



# TEST REPORT

**Reference No.** ..... : WTF18F03106889W  
**Applicant** ..... : Mid Ocean Brands B.V.  
**Address** ..... : Unit 201 2/F., Laford Centre, 838 Lai Chi Kok Road, Cheung Sha Wan, Kowloon, Hong Kong.  
**Manufacturer** ..... : 103221  
**Product Name** ..... : Bluetooth Speaker  
**Model No.** ..... : CX1449  
**Standards** ..... : **Article 3.1a Health** (EN 62479:2010)  
**Article 3.1a Electrical Safety** (EN 60950-1:2006+A11:2009+A1:2010+A12:2011+A2:2013)\*  
**Article 3.1b EMC** (EN 55032:2015, EN 55024:2010+A1:2015)\*\*  
**Article 3.1b EMC** (ETSI EN 301 489-1 V2.1.1:2017, ETSI EN 301 489-17 V3.1.1: 2017)  
**Article 3.2 Radio spectrum** (ETSI EN 300 328 V2.1.1:2016)  
**Date of Receipt sample** ..... : 2018-05-08  
**Date of Test** ..... : 2018-05-08 to 2018-05-10  
**Date of Issue** ..... : 2018-05-11  
**Test Result** ..... : **Pass**

Remarks:

\*Refer to test report WTF18F03106888S for details.

\*\*Refer to test report WTF18F03106886R1E for details.

The results shown in this test report refer only to the sample(s) tested, this test report cannot be reproduced, except in full, without prior written permission of the company. The report would be invalid without specific stamp of test institute and the signatures of compiler and approver.

**Prepared By:**

**Waltek Services (Foshan) Co., Ltd.**

Address: No. 13-19, 2/F, 2nd Building, Sunlink International Machinery City, Chencun Town, Shunde District, Foshan, Guangdong, China.

Tel:+86-757-23811398

Fax:+86-757-23811381

Compiled by:

Roy Hong / Project Engineer

Approved by:



Tom Xiao / Manager



## 1 Test Summary

Radio Spectrum			
Test	Test Requirement	Limit / Severity	Result
RF output power	ETSI EN 300 328 V2.1.1:2016	≤20dBm	Pass
Duty Cycle, Tx-sequence, Tx-gap	ETSI EN 300 328 V2.1.1:2016	-	N/A
Accumulated Transmit Time, Frequency Occupation and Hopping Sequence	ETSI EN 300 328 V2.1.1:2016	Clause 4.3.1.4.3	Pass
Hopping Frequency Separation	ETSI EN 300 328 V2.1.1:2016	≥100kHz	Pass
Medium Utilization	ETSI EN 300 328 V2.1.1:2016	-	N/A
Adaptivity (Adaptive Frequency Hopping)	ETSI EN 300 328 V2.1.1:2016	-	N/A
Occupied Channel Bandwidth	ETSI EN 300 328 V2.1.1:2016	Within the band 2400-2483.5MHz	Pass
Transmitter unwanted in the OOB domain	ETSI EN 300 328 V2.1.1:2016	Figure 1	Pass
Transmitter unwanted emissions in the spurious domain	ETSI EN 300 328 V2.1.1:2016	Table 4	Pass
Receiver spurious emissions	ETSI EN 300 328 V2.1.1:2016	Table 5	Pass
Receiver Blocking	ETSI EN 300 328 V2.1.1:2016	Clause 4.3.1.12.4	Pass
EMC			
Test	Test Requirement	Class / Severity	Result
Radiation Emission	ETSI EN 301 489-17 V3.1.1:2017	Class B	Pass
Conducted Emissions	ETSI EN 301 489-17 V3.1.1:2017	Class B	N/A
Harmonic Current Emissions	ETSI EN 301 489-17 V3.1.1:2017	Clause 7 of EN 61000-3-2	N/A
Voltage Fluctuations and Flicker	ETSI EN 301 489-17 V3.1.1:2017	Clause 5 of EN 61000-3-3	N/A
Radio frequency electromagnetic field (80 MHz to 6 000MHz)	ETSI EN 301 489-17 V3.1.1:2017	3V/m, 80%, 1kHz, Amp. Mod.	Pass
Electrostatic Discharge (ESD)	ETSI EN 301 489-17 V3.1.1:2017	±4 kV Contact ±2/±4/±8 kV Air	Pass
Fast Transients Common Mode (EFT)	ETSI EN 301 489-17 V3.1.1:2017	AC±0.5/1.0kV	N/A
Voltage Dips and Interruptions	ETSI EN 301 489-17 V3.1.1:2017	0 % UT* for 0.5per 0 % UT* for 1per 70 % UT* for 25per 0 % UT* for 250per	N/A
RF common mode 0,15 MHz to 80 MHz (CS)	ETSI EN 301 489-17 V3.1.1:2017	3Vrms(emf), 80%, 1kHz Amp. Mod.	N/A
Surge	ETSI EN 301 489-17 V3.1.1:2017	±1kV D.M.† ±2kV C.M.‡	N/A



HEALTH			
Test	Test Method	Class / Severity	Result
RF Exposure	EN 62479:2010	-	Pass

Remark:

Pass Test item meets the requirement

N/A Not Applicable

RF In this whole report RF means Radio Frequency



# WALTEK





## 2 Contents

	Page
<b>1 TEST SUMMARY</b> .....	<b>2</b>
<b>2 CONTENTS</b> .....	<b>4</b>
<b>3 GENERAL INFORMATION</b> .....	<b>5</b>
3.1 GENERAL DESCRIPTION OF E.U.T. ....	5
3.2 DETAILS OF E.U.T. ....	5
3.3 CHANNEL LIST.....	5
3.4 ADDITIONAL INFORMATION .....	6
3.5 SUBCONTRACTED.....	8
3.6 ABNORMALITIES FROM STANDARD CONDITIONS.....	8
<b>4 EQUIPMENT USED DURING TEST</b> .....	<b>9</b>
4.1 EQUIPMENT LIST.....	9
4.2 SUPPORT EQUIPMENT.....	11
4.3 MEASUREMENT UNCERTAINTY .....	11
<b>5 RF REQUIREMENTS</b> .....	<b>12</b>
5.1 RF OUTPUT POWER.....	12
5.2 ACCUMULATED TRANSMIT TIME, MINIMUM FREQUENCY OCCUPATION AND HOPPING SEQUENCE .....	14
5.3 HOPPING FREQUENCY SEPARATION.....	18
5.4 OCCUPIED CHANNEL BANDWIDTH.....	19
5.5 TRANSMITTER UNWANTED EMISSIONS IN THE OUT-OF-BAND DOMAIN.....	21
5.6 TRANSMITTER UNWANTED EMISSIONS IN THE SPURIOUS DOMAIN .....	23
5.7 RECEIVER SPURIOUS EMISSIONS.....	24
5.8 RECEIVER BLOCKING.....	25
<b>6 EMC REQUIREMENTS FOR EMISSIONS</b> .....	<b>26</b>
6.1 RADIATED EMISSION .....	26
<b>7 EMC REQUIREMENT FOR IMMUNITY</b> .....	<b>36</b>
7.1 PERFORMANCE CRITERIA .....	36
7.2 ELECTROSTATIC DISCHARGE(ESD).....	37
7.3 RF ELECTROMAGNETIC FIELD (80MHZ TO 6 000MHZ) (RS).....	39
<b>8 HEALTH REQUIREMENTS</b> .....	<b>41</b>
8.1 LIMITS .....	41
8.2 TEST RESULT OF RF EXPOSURE EVALUATION.....	41
<b>9 PHOTOGRAPHS —TEST SETUP</b> .....	<b>42</b>
9.1 PHOTOGRAPH —SPURIOUS EMISSIONS TEST SETUP.....	42
9.2 PHOTOGRAPH - RADIATED EMISSIONS TEST SETUP.....	43
9.3 PHOTOGRAPH - RF ELECTROMAGNETIC FIELD TEST SETUP .....	44
9.4 PHOTOGRAPH - ESD TEST SETUP.....	44
<b>10PHOTOGRAPHS - CONSTRUCTIONAL DETAILS</b> .....	<b>45</b>
10.1 EUT – EXTERNAL PHOTOS .....	45
10.2 EUT – INTERNAL PHOTOS .....	48



### 3 General Information

#### 3.1 General Description of E.U.T.

**Product Name** ..... : Bluetooth Speaker

**Model No.** ..... : CX1449

**Remark** ..... : ---

#### 3.2 Details of E.U.T.

**Frequency Range** ..... : 2402-2480MHz, 79 Channels in total

**Nominal Channel Bandwidth**..... : 1MHz

**Maximum RF Output Power** ..... : -5.89 dBm

**Bluetooth Version** ..... : Bluetooth V4.2+ BR+ EDR

**Type of Modulation** ..... : GFSK,  $\pi/4$ DQPSK

**Antenna installation** ..... : PCB Printed Antenna

**Antenna Gain** ..... : 0dBi

**The lowest oscillator**..... : 24MHz

**Receiver Category**..... : 3

**Supply Voltage**..... : Battery 3.7V or DC 5V by USB port

#### 3.3 Channel List

Channel No.	Frequency (MHz)	Channel No.	Frequency (MHz)	Channel No.	Frequency (MHz)	Channel No.	Frequency (MHz)
1	2402	2	2403	3	2404	4	2405
5	2406	6	2407	7	2408	8	2409
9	2410	10	2411	11	2412	12	2413
13	2414	14	2415	15	2416	16	2417
17	2418	18	2419	19	2420	20	2421
21	2422	22	2423	23	2424	24	2425
25	2426	26	2427	27	2428	28	2429
29	2430	30	2431	31	2432	32	2433
33	2434	34	2435	35	2436	36	2437
37	2438	38	2439	39	2440	40	2441
41	2442	42	2443	43	2444	44	2445
45	2446	46	2447	47	2448	48	2449
49	2450	50	2451	51	2452	52	2453
53	2454	54	2455	55	2456	56	2457
57	2458	58	2459	59	2460	60	2461
61	2462	62	2463	63	2464	64	2465
65	2466	66	2467	67	2468	68	2469
69	2470	70	2471	71	2472	72	2473
73	2474	74	2475	75	2476	76	2477
77	2478	78	2479	79	2480	-	-



### 3.4 Additional information

#### a) The type of modulation used by the equipment:

- FHSS  
 Other forms of modulation

#### b) In case of FHSS modulation:

- In case of non-Adaptive Frequency Hopping equipment:  
The number of Hopping Frequencies: N/A
- In case of Adaptive Frequency Hopping Equipment:  
The maximum number of Hopping Frequencies: 79  
The minimum number of Hopping Frequencies: 79

#### c) Adaptive / non-adaptive equipment:

- non-adaptive Equipment  
 adaptive Equipment without the possibility to switch to a non-adaptive mode  
 adaptive Equipment which can also operate in a non-adaptive mode

#### d) In case of adaptive equipment:

- The equipment has implemented an LBT based DAA mechanism  
 The equipment has implemented a non-LBT based DAA mechanism  
 The equipment can operate in more than one adaptive mode

#### e) In case of non-adaptive Equipment:

The maximum RF Output Power (e.i.r.p.): N/AdBm

The maximum (corresponding) Duty Cycle: N/A %

Equipment with dynamic behaviour, that behaviour is described here. (e.g. the different combinations of duty cycle and corresponding power levels to be declared): N/A

#### f) The different transmit operating modes (tick all that apply):

- Operating mode 1: Single Antenna Equipment
- Equipment with only one antenna
  - Equipment with two diversity antennas but only one antenna active at any moment in time
  - Smart Antenna Systems with two or more antennas, but operating in a (legacy) mode where only one antenna is used (e.g. IEEE 802.11™ [i.3] legacy mode in smart antenna systems)
- Operating mode 2: Smart Antenna Systems - Multiple Antennas without beam forming
- Single spatial stream / Standard throughput / (e.g. IEEE 802.11™ [i.3] legacy mode)
  - High Throughput (> 1 spatial stream) using Nominal Channel Bandwidth 1
  - High Throughput (> 1 spatial stream) using Nominal Channel Bandwidth 2
- Operating mode 3: Smart Antenna Systems - Multiple Antennas with beam forming
- Single spatial stream / Standard throughput (e.g. IEEE 802.11™ [i.3] legacy mode)
  - High Throughput (> 1 spatial stream) using Nominal Channel Bandwidth 1
  - High Throughput (> 1 spatial stream) using Nominal Channel Bandwidth 2



**g) Type of Equipment (stand-alone, combined, plug-in radio device, etc.):**

- Stand-alone  
 Combined Equipment (Equipment where the radio part is fully integrated within another type of equipment)  
 Plug-in radio device (Equipment intended for a variety of host systems)  
 Other .....

**h) The normal and the extreme operating conditions that apply to the equipment:****Normal operating conditions (if applicable):**Operating temperature: **25° C****Extreme operating conditions:**Operating temperature range: Minimum: **-10° C** Maximum **+50° C****i) The intended combination(s) of the radio equipment power settings and one or more antenna assemblies and their corresponding e.i.r.p. levels:**

## • Antenna Type:

- Integral Antenna (information to be provided in case of conducted measurements)  
Antenna Gain:0dBi  
 Dedicated Antennas (equipment with antenna connector)  
 Single power level with corresponding antenna(s)  
 Multiple power settings and corresponding antenna(s)

**j) Describe the test modes available which can facilitate testing:**The EUT can be into the Engineer mode for testing.**k) The equipment type (e.g. Bluetooth®, IEEE 802.11™ [i.3], IEEE 802.15.4™ [i.4], proprietary, etc.):**Bluetooth**l) Geo-location capability supported by the equipment:**

- Yes  
 The geographical location determined by the equipment as defined in clause 4.3.1.13.2 or clause 4.3.2.12.2 is not accessible to the user  
 No

**WALTEK**



### 3.5 Subcontracted

Whether parts of tests for the product have been subcontracted to other labs:

Yes       No

If Yes, list the related test items and lab information:

Test items: Receiver Blocking

Lab information: Waltek Services (Shenzhen) Co., Ltd.

### 3.6 Abnormalities from Standard Conditions

None.



# WALTEK





## 4 Equipment Used during Test

### 4.1 Equipment List

<b>3m Semi-anechoic Chamber for Radiation Emission and Spurious Emission</b>						
<b>Item</b>	<b>Equipment</b>	<b>Manufacturer</b>	<b>Model No.</b>	<b>Serial No.</b>	<b>Last Calibration Date</b>	<b>Calibration Due Date</b>
1	EMI TEST RECEIVER	RS	ESR7	101566	2018-01-18	2019-01-17
2	Spectrum Analyzer	Agilent	N9020A	MY48011796	2018-01-18	2019-01-17
3	Trilog Broadband Antenna	SCHWARZBECK	VULB9162	9162-117	2018-01-18	2019-01-17
4	Coaxial Cable (below 1GHz)	H+S	CBL3-NN-12+3 m	214NN320	2018-01-18	2019-01-17
5	Broad-band Horn Antenna	SCHWARZBECK	BBHA 9120 D	01561	2018-01-18	2019-01-17
6	Broadband Preamplifier (below 1GHz)	SCHWARZBECK	BBV 9743	BBV 9743#170	2018-01-18	2019-01-17
7	Broadband Preamplifier (Above 1GHz)	Lunar E M	LNA1G18-40	20160501002	2018-01-18	2019-01-17
8	Coaxial Cable (above 1GHz)	Times-Microwave	CBL5-NN	-	2018-01-18	2019-01-17
<b>RF Conducted test</b>						
<b>Item</b>	<b>Equipment</b>	<b>Manufacturer</b>	<b>Model No.</b>	<b>Serial No.</b>	<b>Last Calibration Date</b>	<b>Calibration Due Date</b>
1	Environmental Chamber	KSON	THS-D4C-100	5244K	2018-01-18	2019-01-17
2	Spectrum Analyzer	Agilent	N9020A	MY48011796	2018-01-18	2019-01-17
3	ESG VECTOR SIGNAL GENERATOR	Agilent	N5182A	MY50141533	2018-01-18	2019-01-17
4	EXG Analog Signal Generator	Agilent	N5181A	MY48080720	2018-01-18	2019-01-17
5	RF Control Unit	CHANGCHUANG	JS0806-2	-	2018-01-18	2019-01-17
6	USB Wideband Power Sensor	KEYSIGHT	U2021A	MY56510008	2018-01-18	2019-01-17
<b>Mains Terminal Disturbance Voltage (Conducted Emission)</b>						
<b>Item</b>	<b>Equipment</b>	<b>Manufacturer</b>	<b>Model No.</b>	<b>Serial No.</b>	<b>Last Calibration Date</b>	<b>Calibration Due Date</b>
1	EMI Test Receiver	R&S	ESCI	101178	2018-01-18	2019-01-17
2	LISN	R&S	ENV216	101215	2018-01-18	2019-01-17
3	LISN	SCHWARZBECK	NSLK 8128	8128-289	2018-01-18	2019-01-17
4	Cable	HUBER+SUHNER	CBL2-NN-3M	2230300	2018-01-18	2019-01-17



5	Switch	ESE	RSU/M2	---	2018-01-18	2019-01-17
<b>Harmonics and Flicker Measuring System</b>						
Item	Equipment	Manufacturer	Model No.	Serial No.	Last Calibration Date	Calibration Due Date
1	Harmonics and Flicker Measuring System	TESEQ	PROFLINE21 05-400	1133A01498	2018-01-18	2019-01-17
<b>ESD</b>						
Item	Equipment	Manufacturer	Model No.	Serial No.	Last Calibration Date	Calibration Due Date
1	ESD Simulator	TESEQ	NSG437	521	2018-01-18	2019-01-17
<b>Injected Currents</b>						
Item	Equipment	Manufacturer	Model No.	Serial No.	Last Calibration Date	Calibration Due Date
1	Conducted Immunity test system	TESEQ	NSG4070-75	31469	2018-01-18	2019-01-17
2	CDN	TESEQ	M016	31586	2018-01-18	2019-01-17
3	Clamp	TESEQ	KEMZ801	32362	2018-01-18	2019-01-17
<b>Surge</b>						
Item	Equipment	Manufacturer	Model No.	Serial No.	Last Calibration Date	Calibration Due Date
1	Surge Simulator	TESEQ	NSG3060	1395	2018-01-18	2019-01-17
<b>EFT &amp; Voltage Dips and Interruptions</b>						
Item	Equipment	Manufacturer	Model No.	Serial No.	Last Calibration Date	Calibration Due Date
1	EMS test system	TESEQ	NSG3040	1858	2018-01-18	2019-01-17
2	Clamp	TESEQ	CDN8014	31405	2018-01-18	2019-01-17
<b>Radio-frequency electromagnetic fields</b>						
Item	Equipment	Manufacturer	Model No.	Serial No.	Last Calibration Date	Calibration Due Date
1	RF Power Amplifier	OPHIR	5225F	1051/1712	2018-01-18	2019-01-17
2	RF Power Amplifier	OPHIR	5293F	1051/171.	2018-01-18	2019-01-17
3	Stacked double logarithmic periodic antenna	SCHWARZBECK	STLP9128E-SPECIAL	STLP 9128E	2018-01-18	2019-01-17
4	Stacked double logarithmic periodic antenna	SCHWARZBECK	STLP 9149	STLP 9149 #476	2018-01-18	2019-01-17
5	RF signal generator	Agilent	N5181A	MY48080720	2018-01-18	2019-01-17



## 4.2 Support equipment

Item	Equipment	Technical Data	Manufacturer	Model No.	Serial No.
1.	Notebook	AC 230V/50Hz	Lenovo	ThinkPad Edge E430	00426-OEM-8992662-00400

## 4.3 Measurement Uncertainty

Parameter	Uncertainty
Occupied Channel Bandwidth	$\pm 5\%$
RF output power, conducted	$\pm 1.5\text{dB}$
Power Spectral Density, conducted	$\pm 3\text{dB}$
Unwanted Emissions, conducted	$\pm 3\text{dB}$
All emissions, radiated	$\pm 6\text{dB}$
Time	$\pm 5\%$
Duty Cycle	$\pm 5\%$
Temperature	$\pm 1\text{ }^\circ\text{C}$
Humidity	$\pm 5\%$
DC and low frequency voltages	$\pm 3\%$
Conduction disturbance (150kHz~30MHz)	$\pm 2.66\text{dB}$
Radiated Emission(30MHz~1000MHz)	$\pm 4.56\text{dB}$
Radiated Emission(1000MHz~18000MHz)	$\pm 4.66\text{dB}$

# WALTEK





## 5 RF Requirements

### 5.1 RF Output power

<b>Test Requirement</b> .....	:	ETSI EN 300 328 V2.1.1, Clause 4.3.1.2
<b>Test Procedure</b> .....	:	ETSI EN 300 328 V2.1.1, Clause 5.4.2.2.1.2
<b>Limit</b> .....	:	ETSI EN 300 328 V2.1.1, Clause 4.3.1.2.3
<b>Test Result</b> .....	:	Pass

#### 5.1.1 E.U.T. Operation

##### Environmental Conditions:

<b>Temperature</b> .....	:	25°C
<b>Humidity</b> .....	:	49%RH

##### Test Mode:

<b>Input Voltage</b> .....	:	DC 5V
<b>Operating mode</b> .....	:	Transmit mode

**Remark** .....

Pre-Scan has been conducted to determine the worst-case mode from all available modulations. Modulation type  $\pi/4$ DQPSK was selected for the final test.

#### 5.1.2 Test Result

Modulation Type	Test conditions		EIRP (dBm)	Limit (dBm)	Verdict
	Voltage (Vdc)	Temperature (°C)			
$\pi/4$ DQPSK	$V_{nor}=5$	$T_{min}=-10$	-5.9	20.00	Pass
		$T_{nor}=+25$	-5.89		
		$T_{max}=+50$	-5.91		

Remark: EIRP=Conducted output power + ANT gain



**Test Graphs:**

**RF Output Power\_TLVN\_π/4DQPSK**

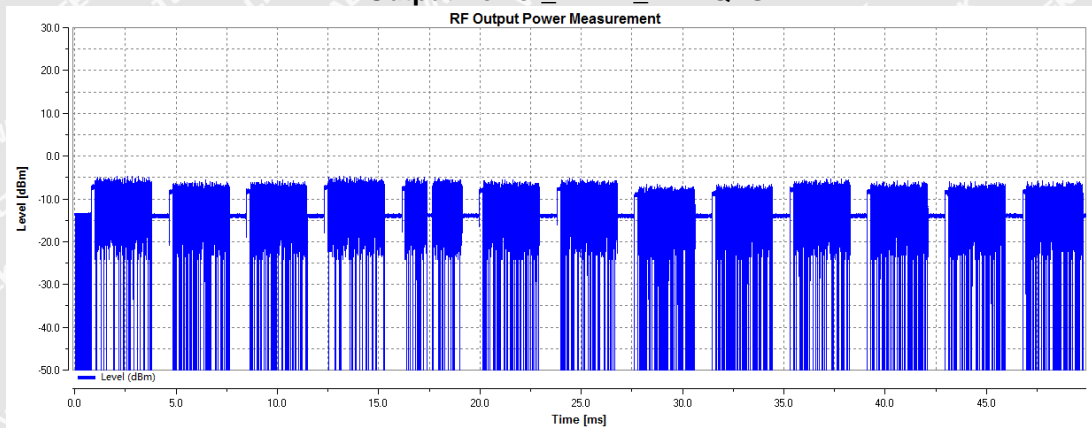

**RF Output Power\_TNVN\_π/4DQPSK**

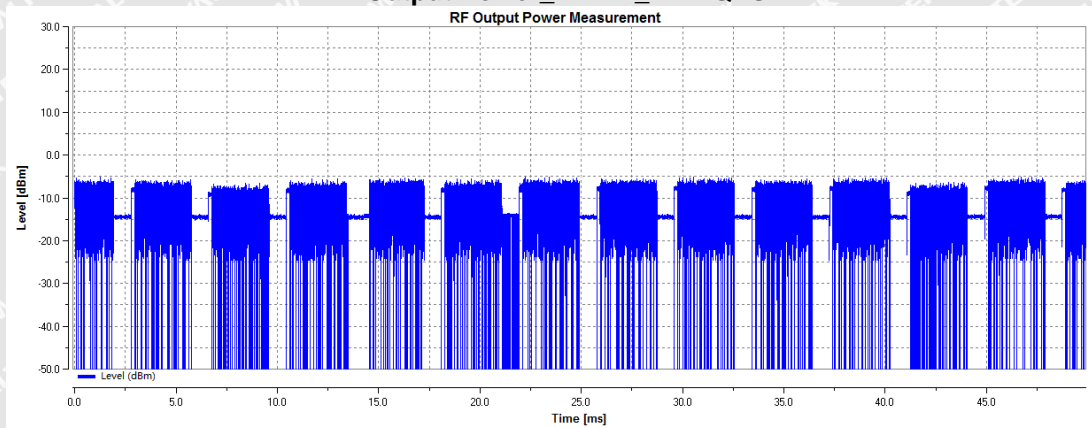

**RF Output Power\_THVN\_π/4DQPSK**

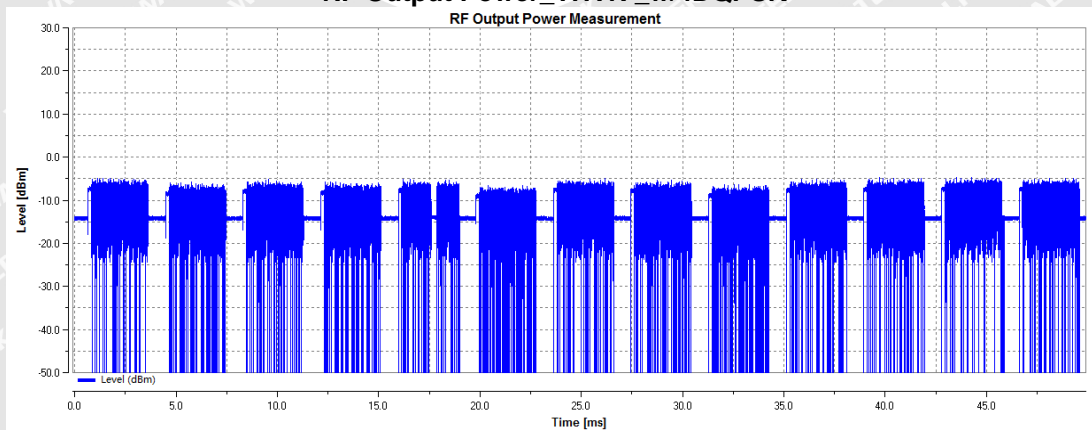



## 5.2 Accumulated Transmit Time, Minimum Frequency Occupation and Hopping Sequence

<b>Test Requirement</b> .....	:	ETSI EN 300 328 V2.1.1, Clause 4.3.1.4
<b>Test Procedure</b> .....	:	ETSI EN 300 328 V2.1.1, Clause 5.4.4.2
<b>Limit</b> .....	:	ETSI EN 300 328 V2.1.1, Clause 4.3.1.4.3
<b>Test Result</b> .....	:	Pass

### 5.2.1 E.U.T. Operation

#### Environmental Conditions:

<b>Temperature</b> .....	:	25°C
<b>Humidity</b> .....	:	49%RH

#### Test Mode:

<b>Input Voltage</b> .....	:	DC 5V
<b>Operating mode</b> .....	:	Transmit mode

**Remark** .....

Pre-Scan has been conducted to determine the worst-case mode from all available modulations. Modulation type GFSK was selected for the final test of Minimum Frequency Occupation and Hopping Sequence. Modulation type  $\pi/4$ DQPSK was selected for the final test of Accumulated Dwell Time.

### 5.2.2 Test Result

#### ◆ Accumulated Dwell Time

Modulation Type	Test Condition	Test Channel	Accumulated Transmit Time (ms)	Limit (ms)	Verdict
$\pi/4$ DQPSK	TNVN	2402MHz	350.760	400	Pass
$\pi/4$ DQPSK	TNVN	2441MHz	381.307	400	Pass
$\pi/4$ DQPSK	TNVN	2480MHz	391.840	400	Pass

#### ◆ Minimum Frequency Occupation

Modulation Type	Test Condition	Test Channel	Frequency occupation times (N)	Limit (N)	Verdict
GFSK	TNVN	2402MHz	1	≥1	Pass
GFSK	TNVN	2441MHz	3		Pass
GFSK	TNVN	2480MHz	3		Pass

#### ◆ Hopping Sequence

Modulation Type	Test Condition	Number of Hopping Channel	Limit	-20 dB Bandwidth(%)	Limit	Verdict
GFSK	TNVN	79	≥15	95.12	70 % of the band 2400MHz-2483.5MHz	Pass





**Test Graphs:**

◆ **Accumulated Dwell Time**

**Accumulated Dwell time\_TNVN\_π/4DQPSK\_2402**

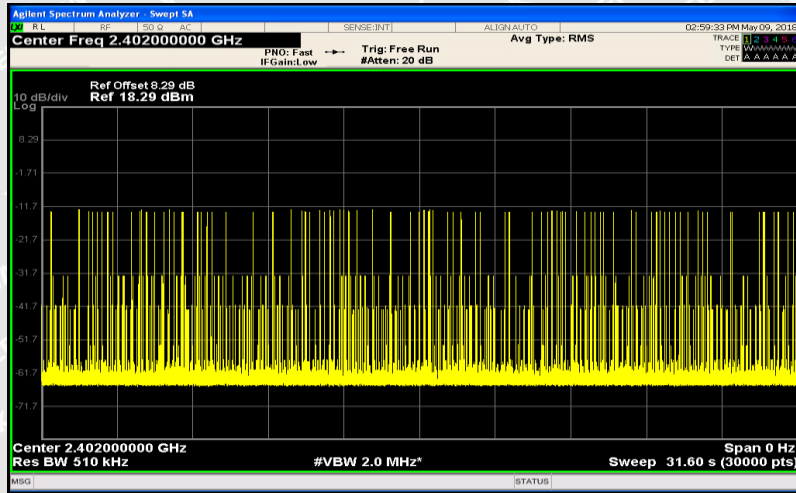

**Accumulated Dwell time\_TNVN\_π/4DQPSK\_2441**

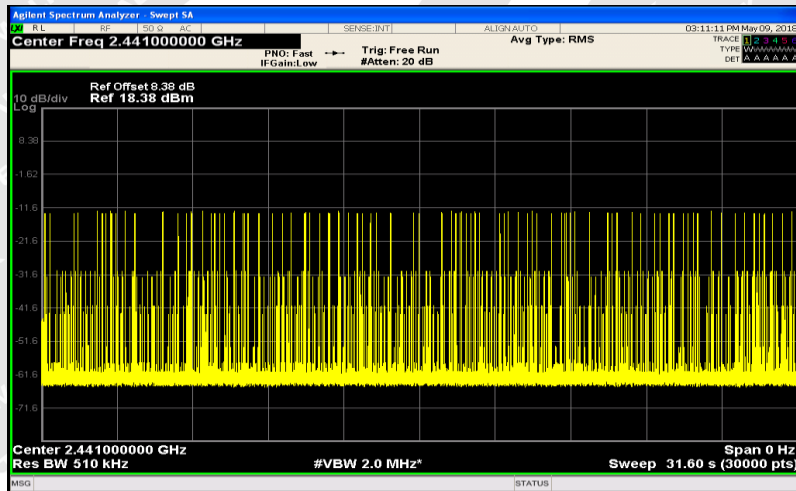

**Accumulated Dwell time\_TNVN\_π/4DQPSK\_2480**

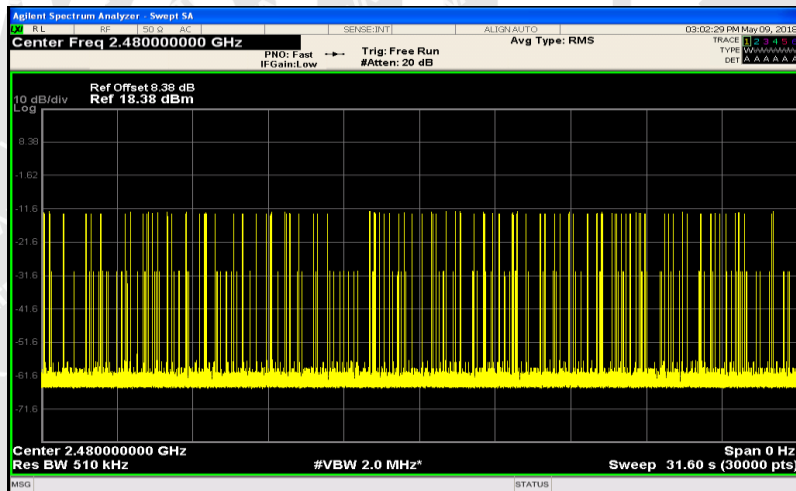



◆ Minimum Frequency Occupation

Minimum Frequency Occupation\_TNVN\_GFSK\_2402

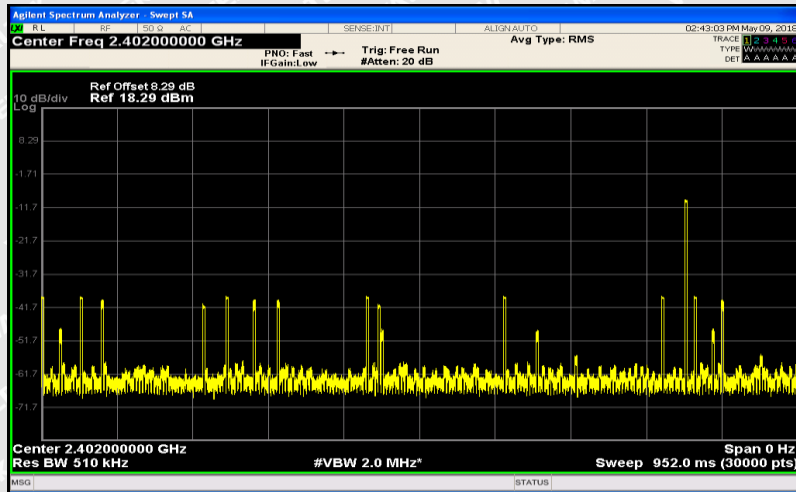

Minimum Frequency Occupation\_TNVN\_GFSK\_2441

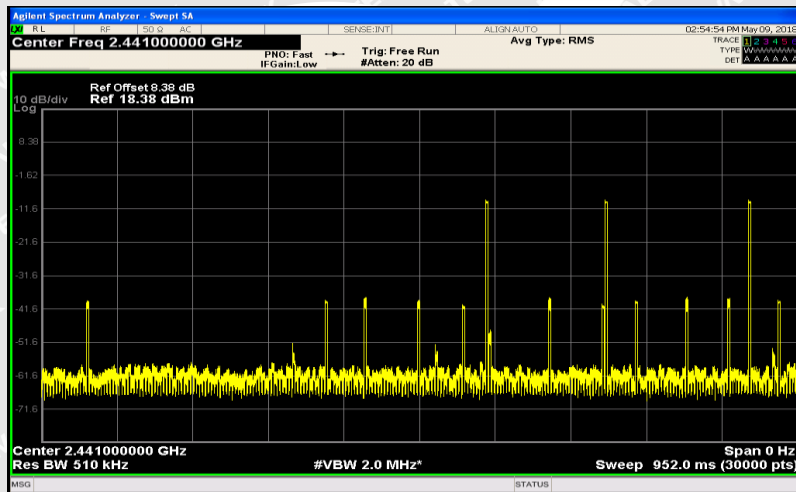

Minimum Frequency Occupation\_TNVN\_GFSK\_2480

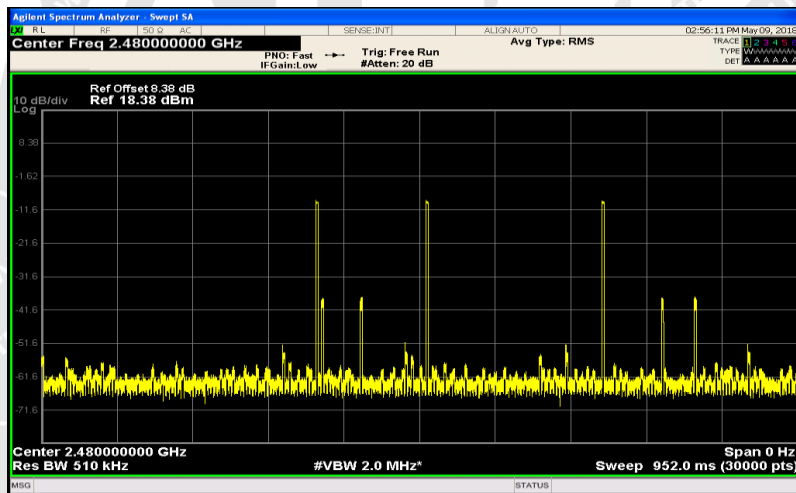



◆ Hopping Sequence

Hopping Sequence\_TNVN\_GFSK

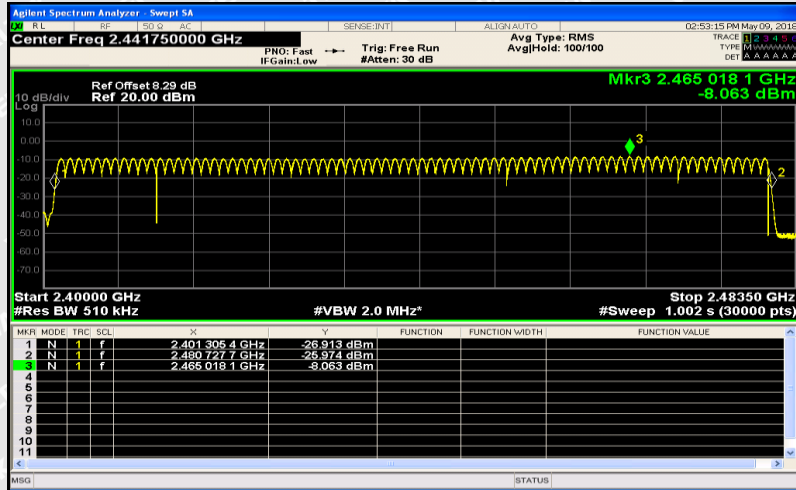

WALTEK





### 5.3 Hopping Frequency Separation

- Test Requirement** ..... : ETSI EN 300 328 V2.1.1, Clause 4.3.1.5
- Test Procedure** ..... : ETSI EN 300 328 V2.1.1, Clause 5.4.5.2
- Test Method** ..... : Option 1 of Clause 5.4.5.2
- Limit** ..... : ETSI EN 300 328 V2.1.1, Clause 4.3.1.5.3
- Test Result** ..... : Pass

#### 5.3.1 E.U.T. Operation

**Environmental Conditions:**

- Temperature**..... : 25°C
- Humidity** ..... : 49%RH

**Test Mode:**

- Input Voltage**..... : DC 5V
- Operating mode** ..... : Transmit mode

**Remark** ..... : Pre-Scan has been conducted to determine the worst-case mode from all available modulations. Modulation type GFSK was selected for the final test.

#### 5.3.2 Test Result

Modulation Type	Test Condition	Test Channel	Channel Separation (MHz)	Limit(kHz)	Verdict
GFSK	TNVN	2441MHz	0.978	≥100	Pass

Test Graphs:

Hopping Frequency Separation\_TNVN\_GFSK\_2441





## 5.4 Occupied Channel Bandwidth

<b>Test Requirement</b> .....	:	ETSI EN 300 328 V2.1.1, Clause 4.3.1.8
<b>Test Procedure</b> .....	:	ETSI EN 300 328 V2.1.1, Clause 5.4.7.2
<b>Limit</b> .....	:	ETSI EN 300 328 V2.1.1, Clause 4.3.1.8.3
<b>Test Result</b> .....	:	Pass

### 5.4.1 E.U.T. Operation

#### Environmental Conditions:

<b>Temperature</b> .....	:	25°C
<b>Humidity</b> .....	:	49%RH

#### Test Mode:

<b>Input Voltage</b> .....	:	DC 5V
<b>Operating mode</b> .....	:	Transmit mode

**Remark** .....

Pre-Scan has been conducted to determine the worst-case mode from all available modulations. Modulation type GFSK was selected for the final test.

### 5.4.2 Test Result

Modulation Type	Test Condition	Test Channel	OBW (MHz)	FL@OBW	FH@OBW	Verdict
GFSK	TNVN	2402MHz	0.87419	2401.582815	---	Pass
GFSK	TNVN	2480MHz	0.87118	---	2480.45422	Pass

# WALTEK



**Test Graphs:**

**Occupied Channel Bandwidth\_TNVN\_GFSK\_2402**



**Occupied Channel Bandwidth\_TNVN\_GFSK\_2480**

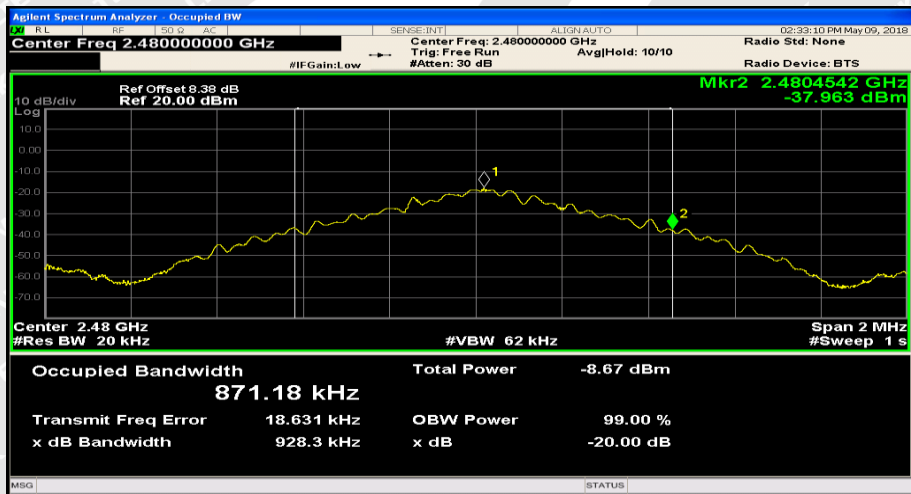





## 5.5 Transmitter unwanted emissions in the out-of-band domain

<b>Test Requirement</b> .....	:	ETSI EN 300 328 V2.1.1, Clause 4.3.1.9
<b>Test Procedure</b> .....	:	ETSI EN 300 328 V2.1.1, Clause 5.4.8.2
<b>Limit</b> .....	:	ETSI EN 300 328 V2.1.1, Clause 4.3.1.9.3
<b>Test Result</b> .....	:	Pass

### 5.5.1 E.U.T. Operation

#### Environmental Conditions:

<b>Temperature</b> .....	:	25°C
<b>Humidity</b> .....	:	49%RH

#### Test Mode:

<b>Input Voltage</b> .....	:	DC 5V
<b>Operating mode</b> .....	:	Transmit mode

**Remark** .....

Pre-Scan has been conducted to determine the worst-case mode from all available modulations. Modulation type GFSK was selected for the final test.

### 5.5.2 Test Result

Modulation Type	Test Condition	Test Channel	Frequency (MHz)	Result (dBm)	Limit (dBm)	Verdict
GFSK	TNVN	2402	2398.500	-60.58	<=-20	Pass
GFSK	TNVN	2402	2399.500	-59.73	<=-10	Pass
GFSK	TNVN	2402	2484.000	-59.20	<=-10	Pass
GFSK	TNVN	2402	2485.000	-62.72	<=-20	Pass
GFSK	TNVN	2480	2398.500	-59.73	<=-20	Pass
GFSK	TNVN	2480	2399.500	-60.76	<=-10	Pass
GFSK	TNVN	2480	2484.000	-62.19	<=-10	Pass
GFSK	TNVN	2480	2485.000	-58.86	<=-20	Pass



**Test Graphs:**

**Transmitter unwanted emissions in the OOB domain\_TNVN\_GFSK\_2402\_2400MHz-2BW to 2400MHz**

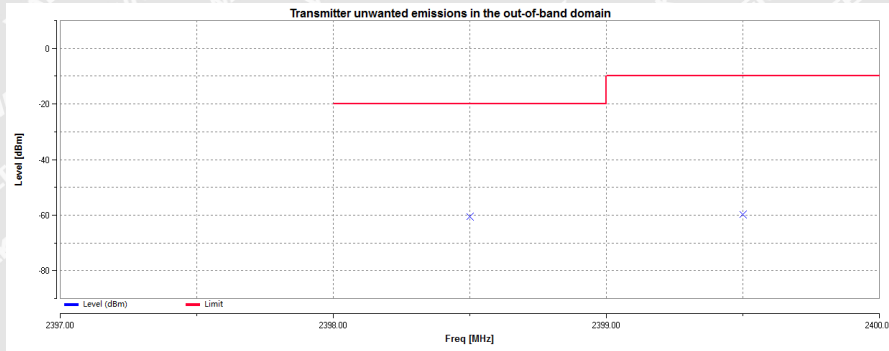

**Transmitter unwanted emissions in the OOB domain\_TNVN\_GFSK\_2402\_2483.5MHz to 2483.5MHz+2BW**

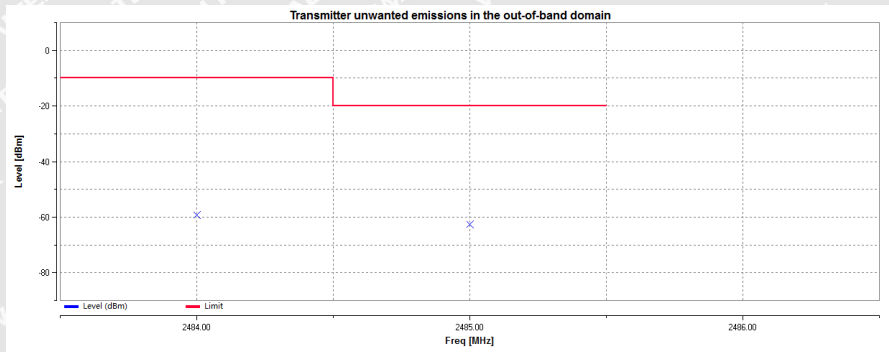

**Transmitter unwanted emissions in the OOB domain\_TNVN\_GFSK\_2480\_2400MHz-2BW to 2400MHz**

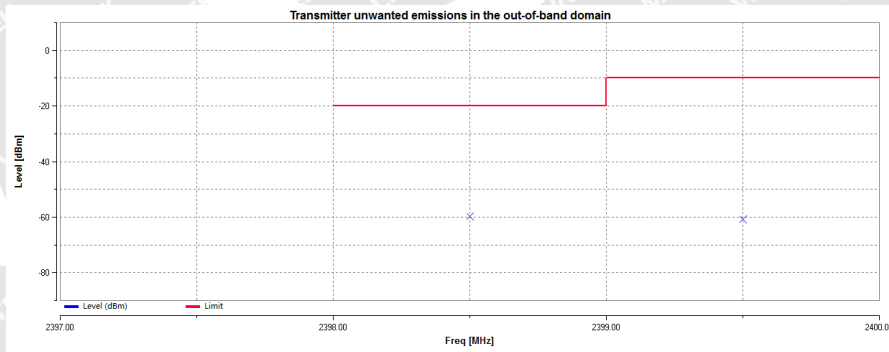

**Transmitter unwanted emissions in the OOB domain\_TNVN\_GFSK\_2402\_2483.5MHz to 2483.5MHz+2BW**

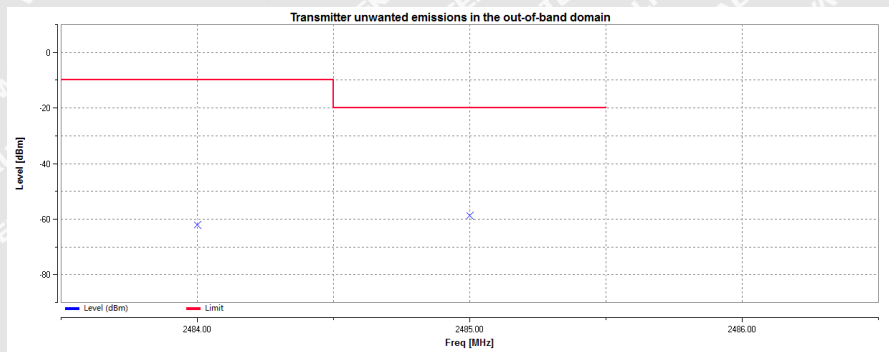



## 5.6 Transmitter unwanted emissions in the spurious domain

<b>Test Requirement</b> .....	:	ETSI EN 300 328 V2.1.1, Clause 4.3.1.10
<b>Test Procedure</b> .....	:	ETSI EN 300 328 V2.1.1, Clause 5.4.9.2
<b>Limit</b> .....	:	ETSI EN 300 328 V2.1.1, Clause 4.3.1.10.3, Table 4
<b>Test Result</b> .....	:	Pass

### 5.6.1 E.U.T. Operation

#### Environmental Conditions:

<b>Temperature</b> .....	:	25°C
<b>Humidity</b> .....	:	49%RH

#### Test Mode:

<b>Input Voltage</b> .....	:	DC 5V
<b>Operating mode</b> .....	:	Transmit mode

**Remark** .....

Pre-Scan has been conducted to determine the worst-case mode from all available modulations. Modulation type GFSK was selected for the final test.

### 5.6.2 Test Result

Frequency (MHz)	Receiver Reading (dBμV)	Turn table Angle (°)	RX Antenna		Substituted			Absolute Level (dBm)	Limit (dBm)	Margin (dB)
			Height (m)	Polar (H/V)	SG Level (dBm)	Cable (dB)	Antenna Gain (dB)			
<b>TX_TNPN_GFSK_2402</b>										
823.46	20.90	102	1.1	H	-74.61	0.22	0.00	-74.39	-54	-20.39
823.46	20.20	245	1.2	V	-75.46	0.22	0.00	-75.24	-54	-21.24
4804.36	50.65	206	1.8	H	-40.52	2.64	12.70	-50.58	-30	-20.58
4804.36	49.99	169	1.4	V	-38.25	2.64	12.70	-48.31	-30	-18.31
6558.04	36.90	282	1.5	H	-51.50	2.98	13.00	-61.52	-30	-31.52
6558.04	36.55	210	1.2	V	-51.49	2.98	13.00	-61.51	-30	-31.51
<b>TX_TNPN_GFSK_2480</b>										
578.68	24.71	210	1.6	H	-74.66	0.18	0.00	-74.48	-54	-20.48
578.68	23.41	109	1.2	V	-76.00	0.18	0.00	-75.82	-54	-21.82
4960.04	45.75	166	1.1	H	-43.76	2.72	12.70	-53.74	-30	-23.74
4960.04	44.79	204	1.7	V	-44.05	2.72	12.70	-54.03	-30	-24.03
5991.99	37.33	173	1.5	H	-51.07	2.98	13.00	-61.09	-30	-31.09
5991.99	37.52	134	1.2	V	-50.52	2.98	13.00	-60.54	-30	-30.54





## 5.7 Receiver spurious emissions

<b>Test Requirement</b> .....	:	ETSI EN 300 328 V2.1.1, Clause 4.3.1.11
<b>Test Procedure</b> .....	:	ETSI EN 300 328 V2.1.1, Clause 5.4.10.2
<b>Limit</b> .....	:	ETSI EN 300 328 V2.1.1, Clause 4.3.1.11.3, Table 5
<b>Test Result</b> .....	:	Pass

### 5.7.1 E.U.T. Operation

#### Environmental Conditions:

<b>Temperature</b> .....	:	25°C
<b>Humidity</b> .....	:	49%RH

#### Test Mode:

<b>Input Voltage</b> .....	:	DC 5V
<b>Operating mode</b> .....	:	Receive mode

**Remark** .....

Pre-Scan has been conducted to determine the worst-case mode from all available modulations. Modulation type GFSK was selected for the final test.

### 5.7.2 Test Result

Frequency (MHz)	Receiver Reading (dBμV)	Turn table Angle (°)	RX Antenna		Substituted			Absolute Level (dBm)	Limit (dBm)	Margin (dB)
			Height (m)	Polar (H/V)	SG Level (dBm)	Cable (dB)	Antenna Gain (dB)			
<b>RX_TNVN_GFSK_2402</b>										
710.46	24.90	201	1.2	H	-74.77	0.20	0.00	-74.57	-57	-17.57
710.46	23.76	162	1.6	V	-75.16	0.20	0.00	-74.96	-57	-17.96
4800.54	45.67	237	1.7	H	-45.50	2.64	12.70	-55.56	-47	-8.56
4800.54	44.04	138	1.2	V	-44.20	2.64	12.70	-54.26	-47	-7.26
<b>RX_TNVN_GFSK_2480</b>										
885.83	19.87	169	1.3	H	-75.52	0.22	0.00	-75.30	-57	-18.30
885.83	18.89	264	1.2	V	-76.35	0.22	0.00	-76.13	-57	-19.13
4800.54	44.54	201	1.5	H	-46.63	2.64	12.70	-56.69	-47	-9.69
4800.54	46.33	198	1.6	V	-41.91	2.64	12.70	-51.97	-47	-4.97



## 5.8 Receiver Blocking

<b>Test Requirement</b> .....	:	ETSI EN 300 328 V2.1.1, Clause 4.3.1.12
<b>Test Procedure</b> .....	:	ETSI EN 300 328 V2.1.1, Clause 5.4.11.2
<b>Limit</b> .....	:	ETSI EN 300 328 V2.1.1, Clause 4.3.1.12.4, table 8
<b>Receiver Category</b> .....	:	3
<b>Test Result</b> .....	:	Pass

### 5.8.1 E.U.T. Operation

#### Environmental Conditions:

<b>Temperature</b> .....	:	25°C
<b>Humidity</b> .....	:	49%RH

#### Test Mode:

<b>Input Voltage</b> .....	:	DC 5V
<b>Operating mode</b> .....	:	Receive mode
<b>Remark</b> .....	:	Pre-Scan has been conducted to determine the worst-case mode from all available modulations. Modulation type GFSK was selected for the final test.

### 5.8.2 Test Result

Pmin=-79.32dBm, Receiver Category: 3							
Modulation Type	Wanted Signal mean Power (dBm)	Blocking Signal Frequency (MHz)	Blocking Signal Power (dB)	Type of Blocking Signal	Measured PER (%)	Limit PER (%)	Performance Criteria
GFSK	P <sub>min</sub> +12dB	2380	-57	CW	0.045	≤10	Compliance
GFSK	P <sub>min</sub> +12dB	2503.5	-57	CW	0.052	≤10	Compliance
GFSK	P <sub>min</sub> +12dB	2300	-47	CW	0.055	≤10	Compliance
GFSK	P <sub>min</sub> +12dB	2583.5	-47	CW	0.053	≤10	Compliance

Remark: The minimum performance criterion shall be a PER less than or equal to 10%.



## 6 EMC Requirements for Emissions

### 6.1 Radiated Emission

<b>Test Requirement</b> .....	: ETSI EN 301 489-17
<b>Test Method</b> .....	: ETSI EN 301 489-1, EN 55032, Class B
<b>Frequency Range</b> .....	: 30MHz to 1GHz, 1GHz to 6GHz
<b>Class/Severity</b> .....	: Class B/ Table A.4 and A.5 of EN 55032
<b>Detector</b> .....	: Peak for pre-scan (120kHz Resolution Bandwidth Below 1GHz; 1MHz Resolution Bandwidth Above 1GHz)

#### 6.1.1 EUT Operation:

##### Operating Environment:

<b>Temperature</b> .....	: 23.5°C
<b>Humidity</b> .....	: 48.9%RH
<b>Atmospheric Pressure</b> .....	: 101.2kPa

##### EUT Operation:

<b>Input Voltage</b> .....	: DC 5V by USB port, or battery 3.7V
<b>Operating Mode</b> .....	: Bluetooth+ charging mode, or Bluetooth+ discharging mode

#### 6.1.2 Test Setup

The radiated emission tests were performed using the setup accordance with the EN 55032.  
Frequency Range: Below 1 000MHz

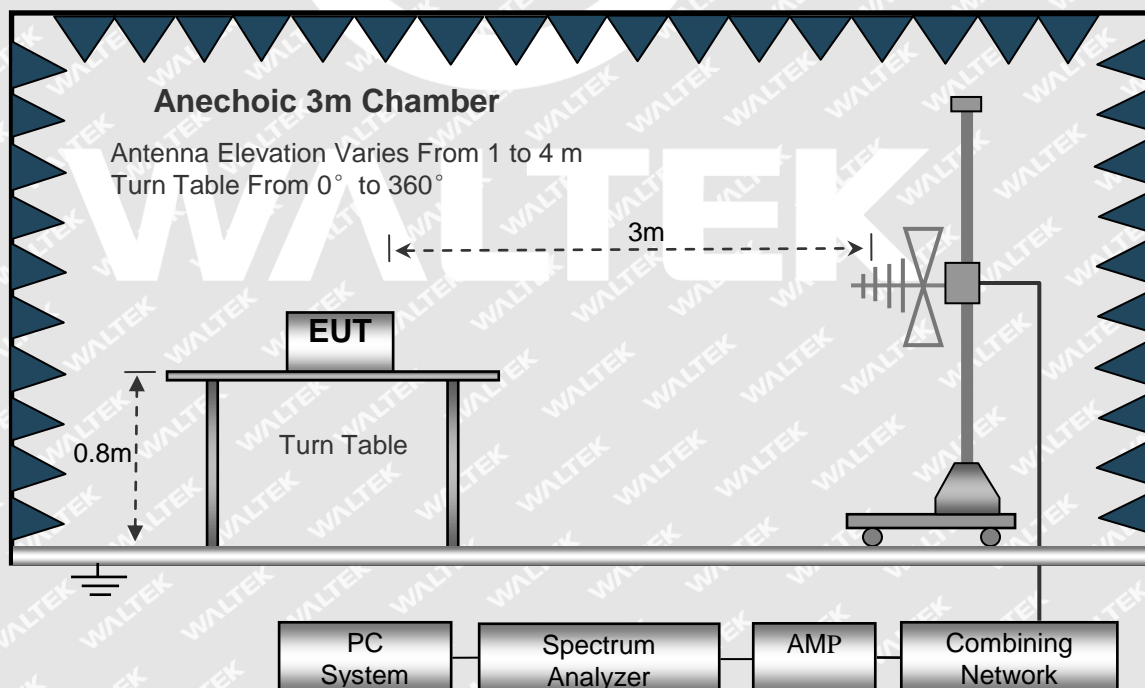





Frequency Range: Above 1 000MHz

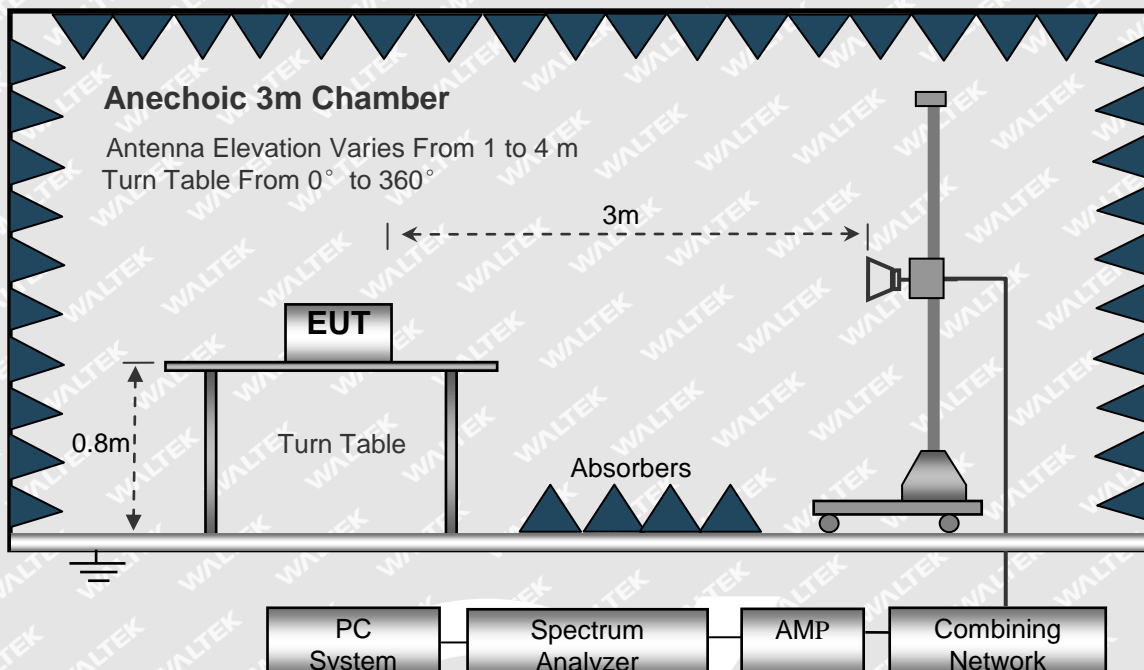

### 6.1.3 Corrected Amplitude & Margin Calculation

The Corrected Amplitude is calculated by adding the Antenna Factor and Cable Factor, and subtracting the Amplifier Gain from the Amplitude reading. The basic equation is as follows:

$$\text{Corr. Ampl.} = \text{Indicated Reading} + \text{Antenna Factor} + \text{Cable Factor} - \text{Amplifier Gain}$$

The “Margin” column of the following data tables indicates the degree of compliance with the applicable limit.

For example, a margin of -7dB means the emission is 7dB below the maximum limit for Class B. The equation for margin calculation is as follows:

$$\text{Margin} = \text{Corr. Ampl.} - \text{Class B Limit}$$





### 6.1.4 Test Result

Frequency Range: 30MHz ~ 1000MHz

Antenna Polarization: Vertical (Bluetooth+ charging mode)

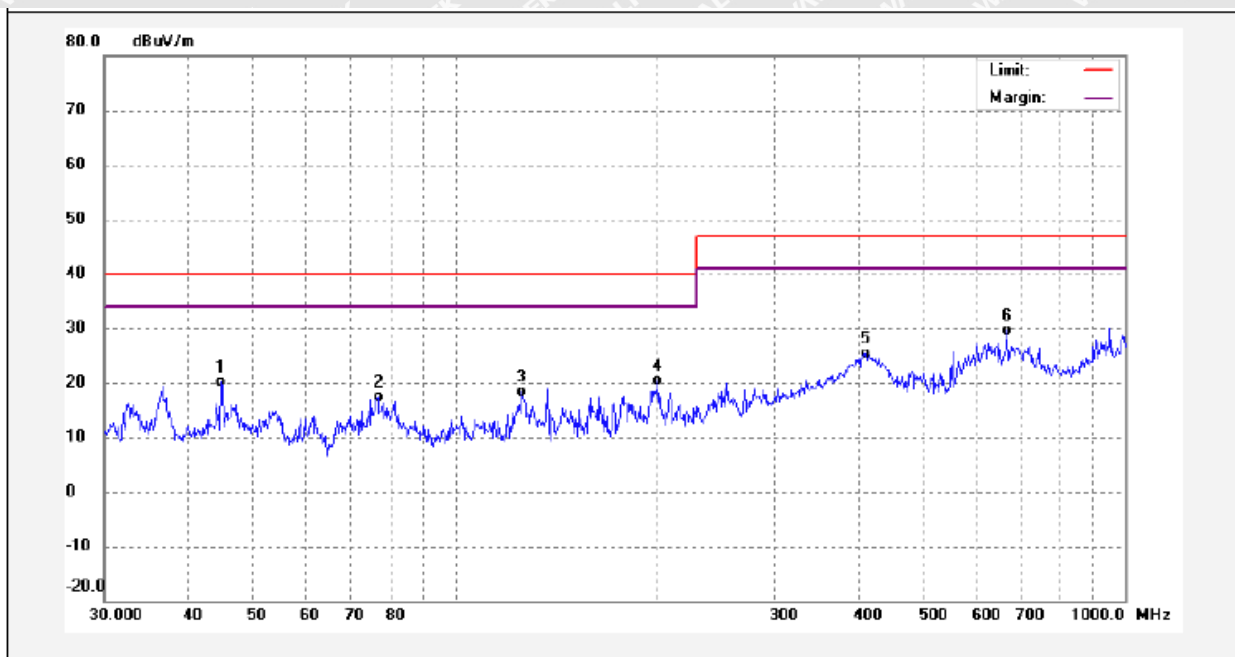

No.	Freq. (MHz)	Reading (dBuV/m)	Factor (dB)	Result (dBuV/m)	Limit (dBuV/m)	Margin (dB)	Detector	Remark
1	44.7433	32.72	-12.62	20.10	40.00	-19.90	QP	
2	76.7808	37.36	-20.08	17.28	40.00	-22.72	QP	
3	125.8864	35.44	-17.16	18.28	40.00	-21.72	QP	
4	200.6881	36.79	-16.47	20.32	40.00	-19.68	QP	
5	410.3825	34.09	-8.67	25.42	47.00	-21.58	QP	
6	665.8035	32.61	-2.91	29.70	47.00	-17.30	QP	





Antenna Polarization: Horizontal (Bluetooth+ charging mode)

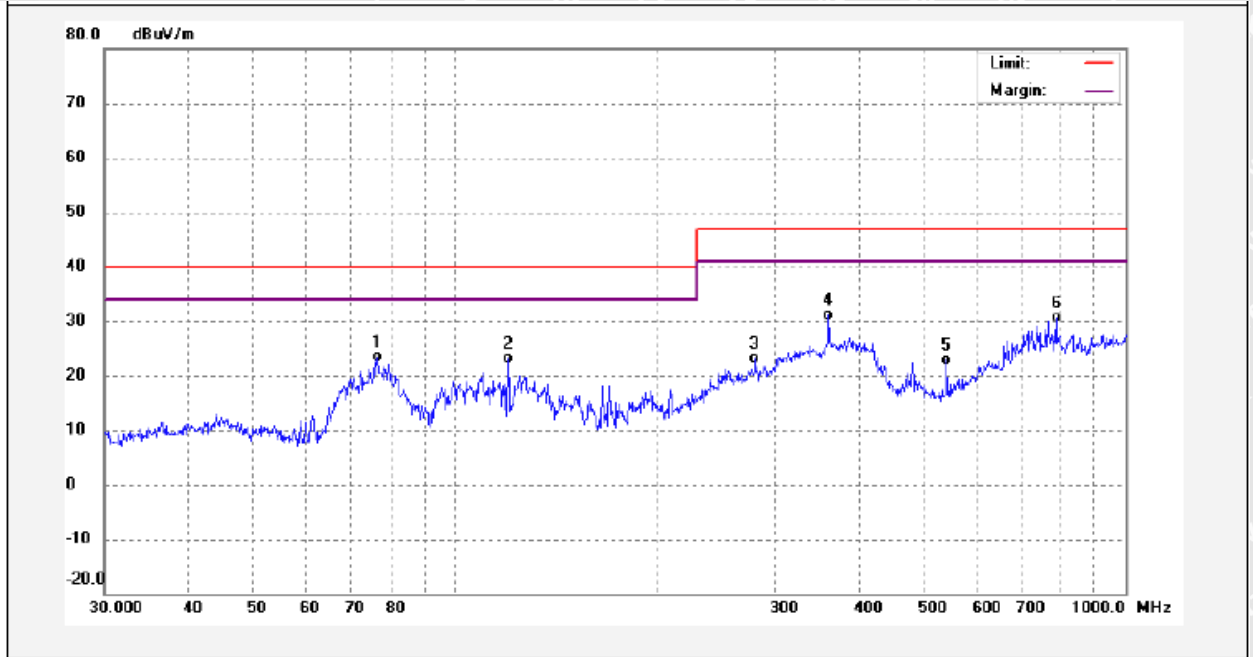

No.	Freq. (MHz)	Reading (dBuV/m)	Factor (dB)	Result (dBuV/m)	Limit (dBuV/m)	Margin (dB)	Detector	Remark
1	76.5121	43.45	-20.02	23.43	40.00	-16.57	QP	
2	119.8556	39.83	-16.58	23.25	40.00	-16.75	QP	
3	280.0237	35.98	-12.88	23.10	47.00	-23.90	QP	
4	360.4476	39.98	-8.87	31.11	47.00	-15.89	QP	
5	541.3725	31.07	-8.11	22.96	47.00	-24.04	QP	
6	787.8513	33.87	-3.26	30.61	47.00	-16.39	QP	

# WALTEK





Antenna Polarization: Vertical (Bluetooth+ discharging mode)

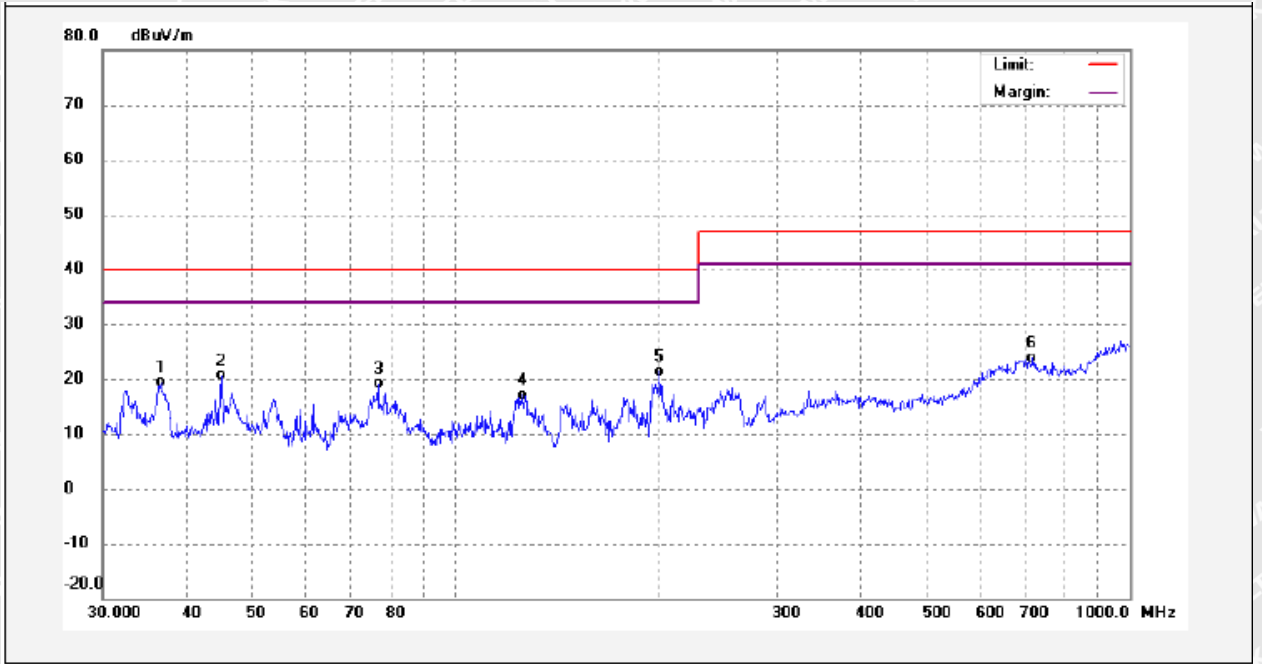

No.	Freq. (MHz)	Reading (dBuV/m)	Factor (dB)	Result (dBuV/m)	Limit (dBuV/m)	Margin (dB)	Detector	Remark
1	36.5092	33.87	-14.55	19.32	40.00	-20.68	QP	
2	44.9006	33.41	-12.66	20.75	40.00	-19.25	QP	
3	76.7808	39.24	-20.08	19.16	40.00	-20.84	QP	
4	125.4457	34.19	-17.10	17.09	40.00	-22.91	QP	
5	200.6881	37.75	-16.47	21.28	40.00	-18.72	QP	
6	716.6820	25.79	-1.99	23.80	47.00	-23.20	QP	





Antenna Polarization: Horizontal (Bluetooth+ discharging mode)

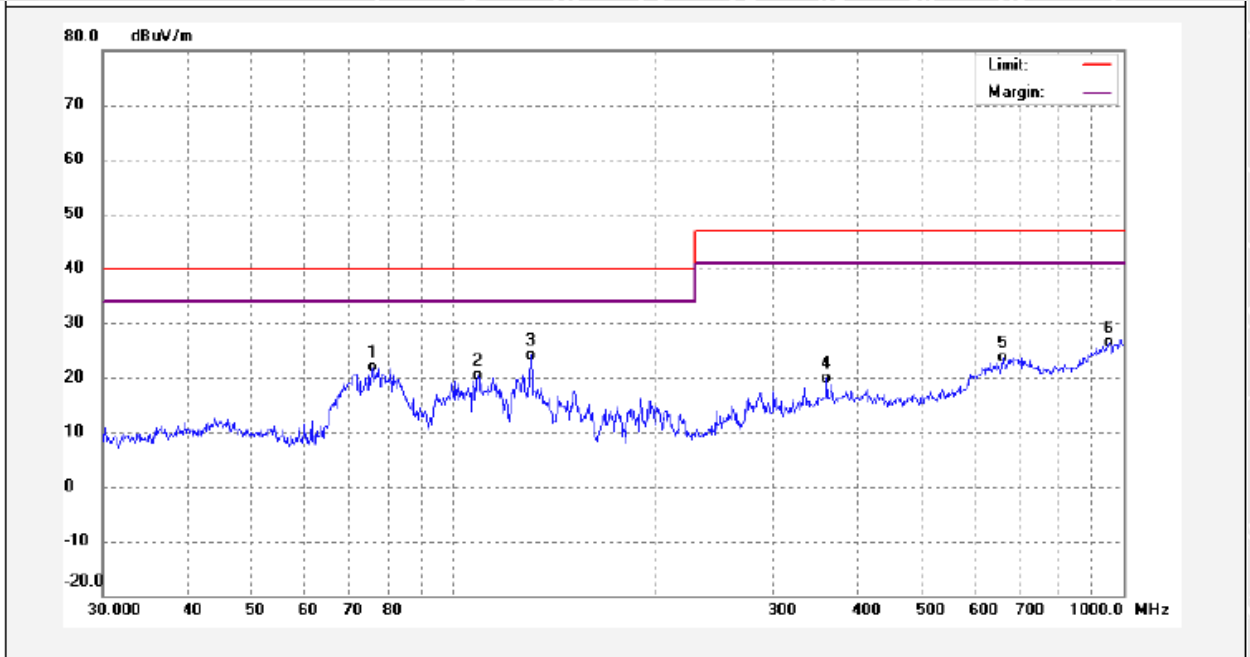

No.	Freq. (MHz)	Reading (dBuV/m)	Factor (dB)	Result (dBuV/m)	Limit (dBuV/m)	Margin (dB)	Detector	Remark
1	75.7114	41.83	-20.01	21.82	40.00	-18.18	QP	
2	108.6470	36.43	-16.05	20.38	40.00	-19.62	QP	
3	130.3789	41.88	-17.75	24.13	40.00	-15.87	QP	
4	360.4476	28.84	-8.87	19.97	47.00	-27.03	QP	
5	661.1505	26.63	-3.00	23.63	47.00	-23.37	QP	
6	952.0937	25.08	1.24	26.32	47.00	-20.68	QP	

# WALTEK



**Frequency Range: 1000MHz ~ 6000MHz**

Antenna Polarization: Vertical (Bluetooth+ charging mode)

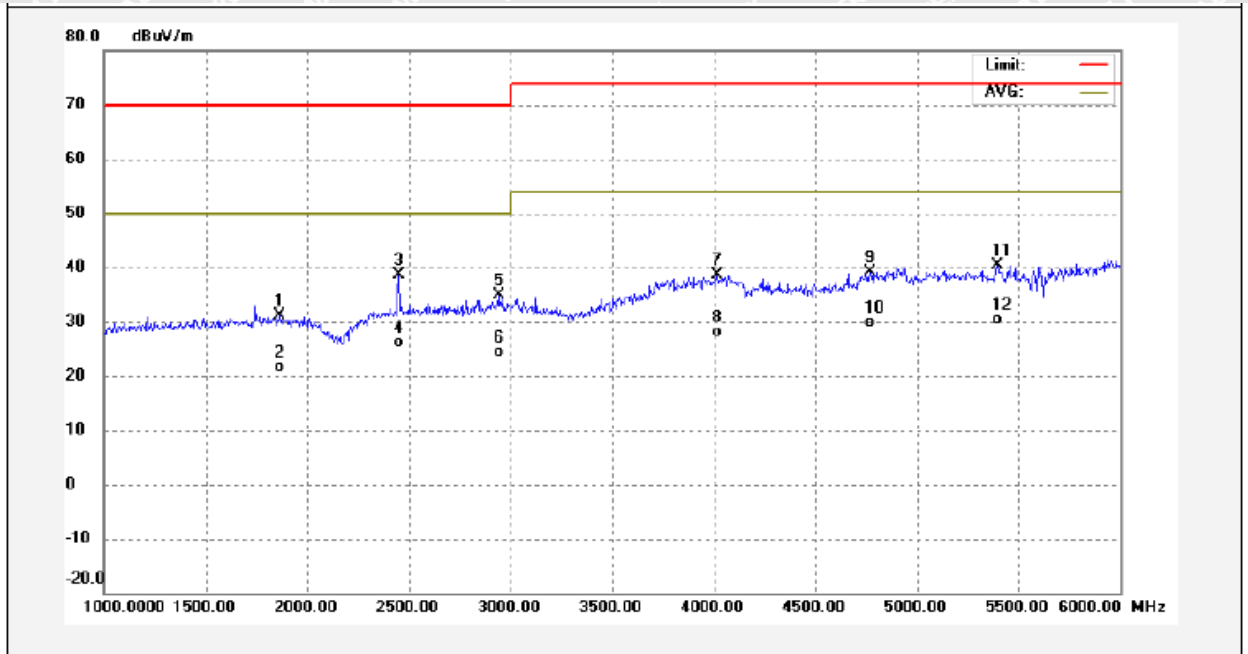

No.	Freq. (MHz)	Reading (dBuV/m)	Factor (dB)	Result (dBuV/m)	Limit (dBuV/m)	Margin (dB)	Detector	Remark
1	1865.000	46.00	-14.87	31.13	70.00	-38.87	peak	
2	1865.000	36.44	-14.87	21.57	50.00	-28.43	AVG	
3	2450.000	51.23	-12.70	38.53	70.00	-31.47	peak	
4	2450.000	38.89	-12.70	26.19	50.00	-23.81	AVG	
5	2940.000	46.43	-11.48	34.95	70.00	-35.05	peak	
6	2940.000	35.77	-11.48	24.29	50.00	-25.71	AVG	
7	4015.000	47.35	-8.70	38.65	74.00	-35.35	peak	
8	4015.000	36.71	-8.70	28.01	54.00	-25.99	AVG	
9	4770.000	45.59	-6.51	39.08	74.00	-34.92	peak	
10	4770.000	36.42	-6.51	29.91	54.00	-24.09	AVG	
11	5395.000	45.82	-5.39	40.43	74.00	-33.57	peak	
12	5395.000	35.87	-5.39	30.48	54.00	-23.52	AVG	





Antenna Polarization: Horizontal (Bluetooth+ charging mode)

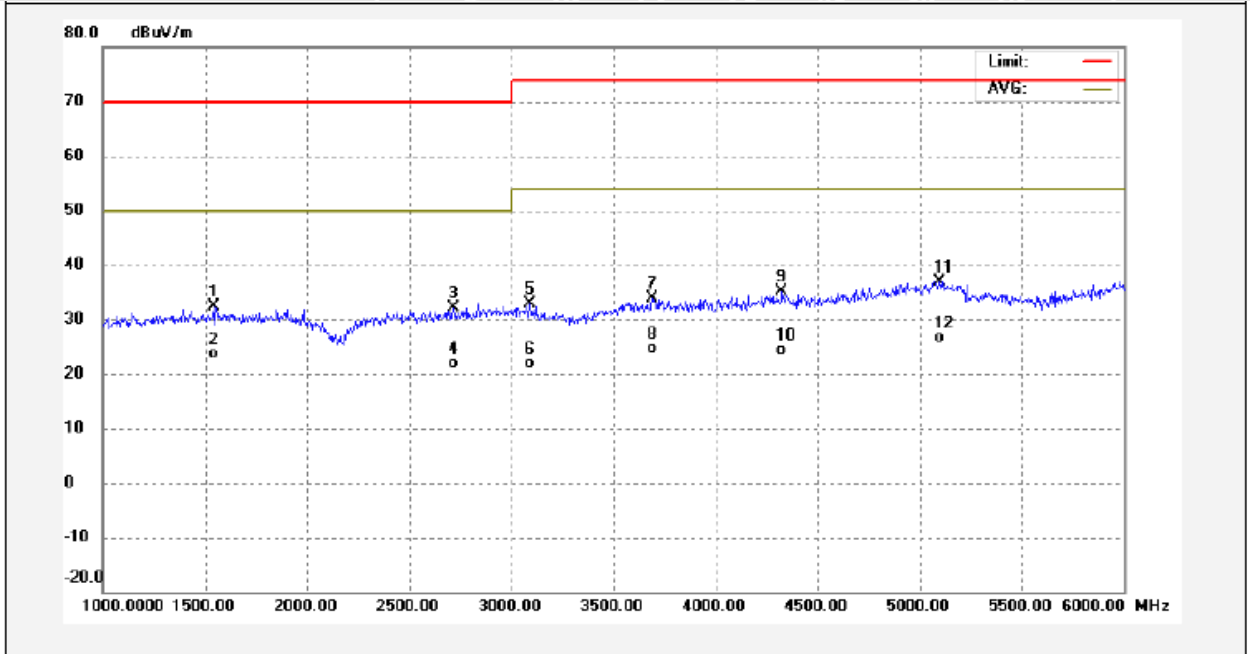

No.	Freq. (MHz)	Reading (dBuV/m)	Factor (dB)	Result (dBuV/m)	Limit (dBuV/m)	Margin (dB)	Detector	Remark
1	1540.000	48.04	-15.78	32.26	70.00	-37.74	peak	
2	1540.000	39.46	-15.78	23.68	50.00	-26.32	AVG	
3	2715.000	46.35	-14.12	32.23	70.00	-37.77	peak	
4	2715.000	35.99	-14.12	21.87	50.00	-28.13	AVG	
5	3090.000	46.00	-13.18	32.82	74.00	-41.18	peak	
6	3090.000	35.06	-13.18	21.88	54.00	-32.12	AVG	
7	3690.000	46.15	-12.28	33.87	74.00	-40.13	peak	
8	3690.000	36.90	-12.28	24.62	54.00	-29.38	AVG	
9	4325.000	46.27	-11.21	35.06	74.00	-38.94	peak	
10	4325.000	35.54	-11.21	24.33	54.00	-29.67	AVG	
11	5095.000	46.44	-9.56	36.88	74.00	-37.12	peak	
12	5095.000	36.24	-9.56	26.68	54.00	-27.32	AVG	



Antenna Polarization: Vertical (Bluetooth+ discharging mode)

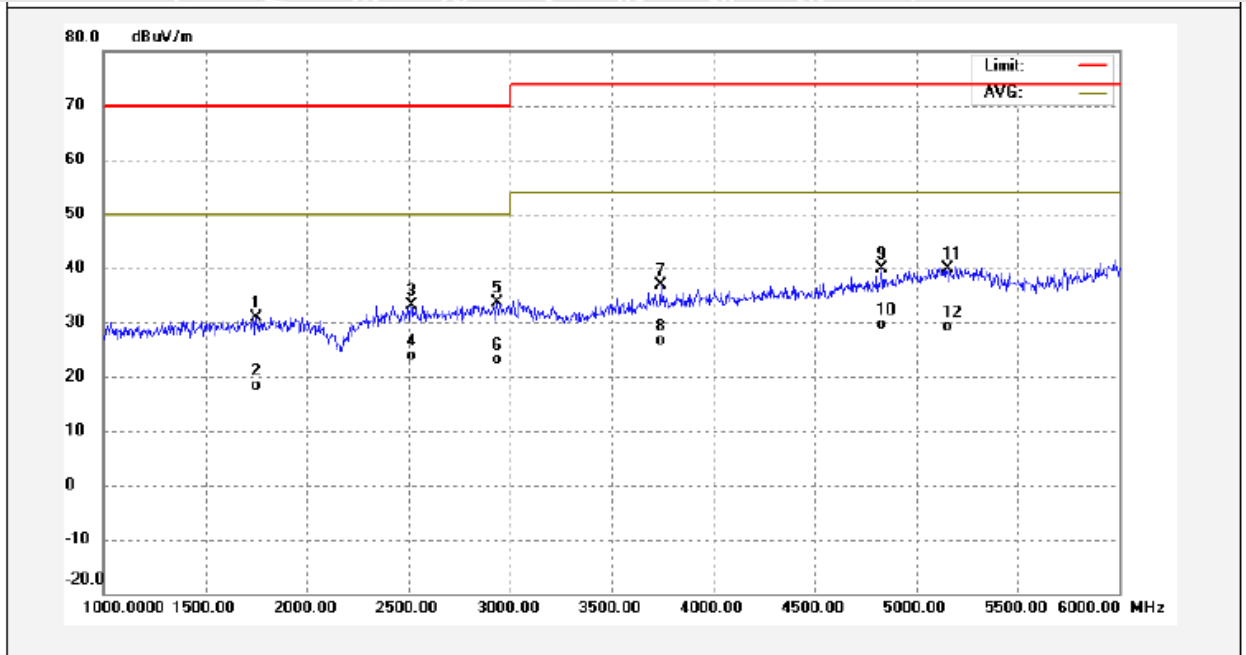

No.	Freq. (MHz)	Reading (dBuV/m)	Factor (dB)	Result (dBuV/m)	Limit (dBuV/m)	Margin (dB)	Detector	Remark
1	1750.000	46.07	-15.17	30.90	70.00	-39.10	peak	
2	1750.000	33.63	-15.17	18.46	50.00	-31.54	AVG	
3	2515.000	45.67	-12.47	33.20	70.00	-36.80	peak	
4	2515.000	36.39	-12.47	23.92	50.00	-26.08	AVG	
5	2935.000	45.03	-11.50	33.53	70.00	-36.47	peak	
6	2935.000	34.67	-11.50	23.17	50.00	-26.83	AVG	
7	3740.000	46.58	-9.63	36.95	74.00	-37.05	peak	
8	3740.000	36.32	-9.63	26.69	54.00	-27.31	AVG	
9	4830.000	46.17	-6.23	39.94	74.00	-34.06	peak	
10	4830.000	35.76	-6.23	29.53	54.00	-24.47	AVG	
11	5155.000	45.44	-5.45	39.99	74.00	-34.01	peak	
12	5155.000	34.60	-5.45	29.15	54.00	-24.85	AVG	



Antenna Polarization: Horizontal (Bluetooth+ discharging mode)

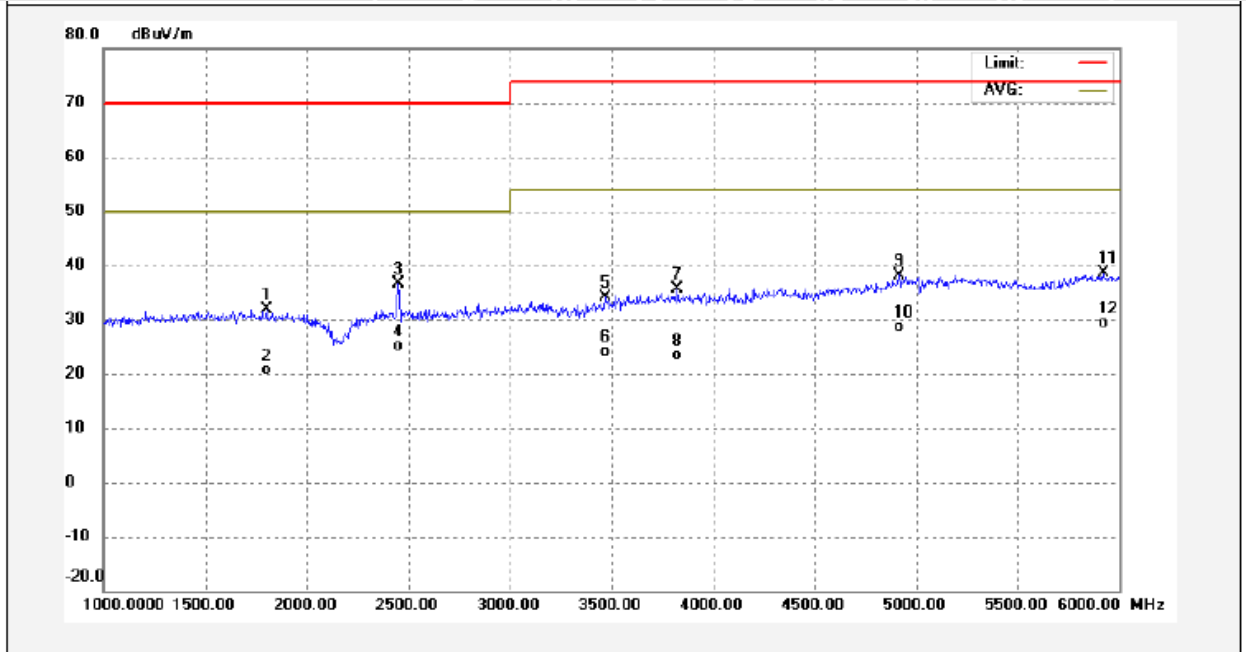

No.	Freq. (MHz)	Reading (dBuV/m)	Factor (dB)	Result (dBuV/m)	Limit (dBuV/m)	Margin (dB)	Detector	Remark
1	1800.000	47.55	-15.63	31.92	70.00	-38.08	peak	
2	1800.000	36.21	-15.63	20.58	50.00	-29.42	AVG	
3	2450.000	51.29	-14.78	36.51	70.00	-33.49	peak	
4	2450.000	39.96	-14.78	25.18	50.00	-24.82	AVG	
5	3470.000	46.71	-12.61	34.10	74.00	-39.90	peak	
6	3470.000	36.70	-12.61	24.09	54.00	-29.91	AVG	
7	3825.000	47.82	-12.10	35.72	74.00	-38.28	peak	
8	3825.000	35.39	-12.10	23.29	54.00	-30.71	AVG	
9	4915.000	48.07	-9.82	38.25	74.00	-35.75	peak	
10	4915.000	38.54	-9.82	28.72	54.00	-25.28	AVG	
11	5920.000	46.54	-8.03	38.51	74.00	-35.49	peak	
12	5920.000	37.43	-8.03	29.40	54.00	-24.60	AVG	





## 7 EMC Requirement for Immunity

### 7.1 Performance Criteria

#### 7.1.1 General performance criteria

The performance criteria are:

- performance criteria A for immunity tests with phenomena of a continuous nature;
- performance criteria B for immunity tests with phenomena of a transient nature;
- performance criteria C for immunity tests with power interruptions exceeding a certain time.

The equipment shall meet the minimum performance criteria as specified in the following clauses.

#### 7.1.2 Performance table

Criteria	During test	After test
A	Shall operate as intended. May show degradation of performance (see note 1). Shall be no loss of function. Shall be no unintentional transmissions.	Shall operate as intended. Shall be no degradation of performance (see note 2). Shall be no loss of function. Shall be no loss of stored data or user programmable functions.
B	May show loss of function (one or more). May show degradation of performance (see note 1). No unintentional transmissions.	Functions shall be self-recoverable. Shall operate as intended after recovering. Shall be no degradation of performance (see note 2). Shall be no loss of stored data or user programmable functions.
C	May be loss of function (one or more).	Functions shall be recoverable by the operator. Shall operate as intended after recovering. Shall be no degradation of performance (see note 2).

##### NOTE 1:

Degradation of performance during the test is understood as a degradation to a level not below a minimum performance level specified by the manufacturer for the use of the apparatus as intended. In some cases the specified minimum performance level may be replaced by a permissible degradation of performance. If the minimum performance level or the permissible performance degradation is not specified by the manufacturer then either of these may be derived from the product description and documentation (including leaflets and advertising) and what the user may reasonably expect from the apparatus if used as intended.

##### NOTE 2:

No degradation of performance after the test is understood as no degradation below a minimum performance level specified by the manufacturer for the use of the apparatus as intended. In some cases the specified minimum performance level may be replaced by a permissible degradation of performance. After the test no change of actual operating data or user retrievable data is allowed. If the minimum performance level or the permissible performance degradation is not specified by the manufacturer then either of these may be derived from the product description and documentation (including leaflets and advertising) and what the user may reasonably expect from the apparatus if used as intended.



## 7.2 Electrostatic Discharge(ESD)

<b>Test Requirement</b> .....	: ETSI EN 301 489-17
<b>Test Method</b> .....	: ETSI EN 301 489-1, EN 61000-4-2
<b>Discharge Impedance</b> .....	: 330 $\Omega$ / 150 pF
<b>Discharge Voltage</b> .....	: Air Discharge: +/-2,4,8 kV Contact Discharge: +/-2,4 kV HCP & VCP: +/-2,4 kV
<b>Polarity</b> .....	: Positive & Negative
<b>Discharge Repeat Times</b> .....	: At Least 20 times at each test point
<b>Discharge Mode</b> .....	: Single Discharge
<b>Discharge Period</b> .....	: 1 second minimum

### 7.2.1 E.U.T. Operation

#### Operating Environment:

<b>Temperature</b> .....	: 23.1°C
<b>Humidity</b> .....	: 58.3%RH
<b>Atmospheric Pressure</b> .....	: 100.2kPa

#### EUT Operation:

<b>Input Voltage</b> .....	: DC 5V by USB port, or battery 3.7V
<b>Operating Mode</b> .....	: Bluetooth+ charging mode, or Bluetooth+ discharging mode

### 7.2.2 Block Diagram of Setup

The ESD test was performed in accordance with the EN 61000-4-2.

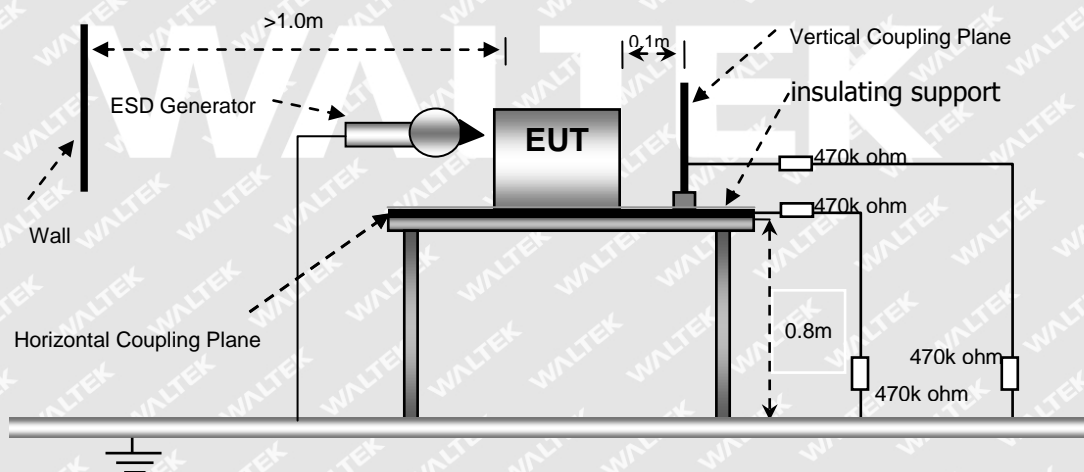



### 7.2.3 Test Result

Direct Discharge			Performance Criteria	
Discharge Level (kV)	Performance Criterion	Test Point	Contact Discharge	Air Discharge
±8	B	1	N/A	Pass*
±4	B	2	Pass*	N/A

Remark:

Test points 1. All Exposed Surface & Seams; 2. All metallic part

\* During the test no deviation was detected to the selected operation mode(s)

Indirect Discharge			Performance Criteria	
Discharge Level (kV)	Performance Criterion	Test Point	Horizontal Coupling	Vertical Coupling
±4	B	1	Pass*	Pass*

Remark:

Test points 1. All sides

\* During the test no deviation was detected to the selected operation mode(s)

# WALTEK





### 7.3 RF Electromagnetic Field (80MHz to 6 000MHz) (RS)

- Test Requirement** ..... : ETSI EN 301 489-17
- Test Method** ..... : ETSI EN 301 489-1, EN 61000-4-3
- Face of EUT**..... : Front, Back, Left, Right
- Frequency Range** ..... : 80MHz to 6 000MHz
- Test Level**..... : 3V/m
- Modulation** ..... : 80%, 1kHz Amplitude Modulation.
- Antenna polarisation**..... : Horizontal& Vertical

#### 7.3.1 E.U.T. Operation

**Operating Environment:**

- Temperature**..... : 20.1°C
- Humidity** ..... : 58.2%RH
- Atmospheric Pressure** ..... : 100.1kPa

**EUT Operation:**

- Input Voltage**..... : DC 5V by USB port, or battery 3.7V
- Operating Mode** ..... : Bluetooth+ charging mode, or Bluetooth+ discharging mode

#### 7.3.2 Block Diagram of Setup

The Radiated Immunity test was performed in accordance with the EN 61000-4-3.

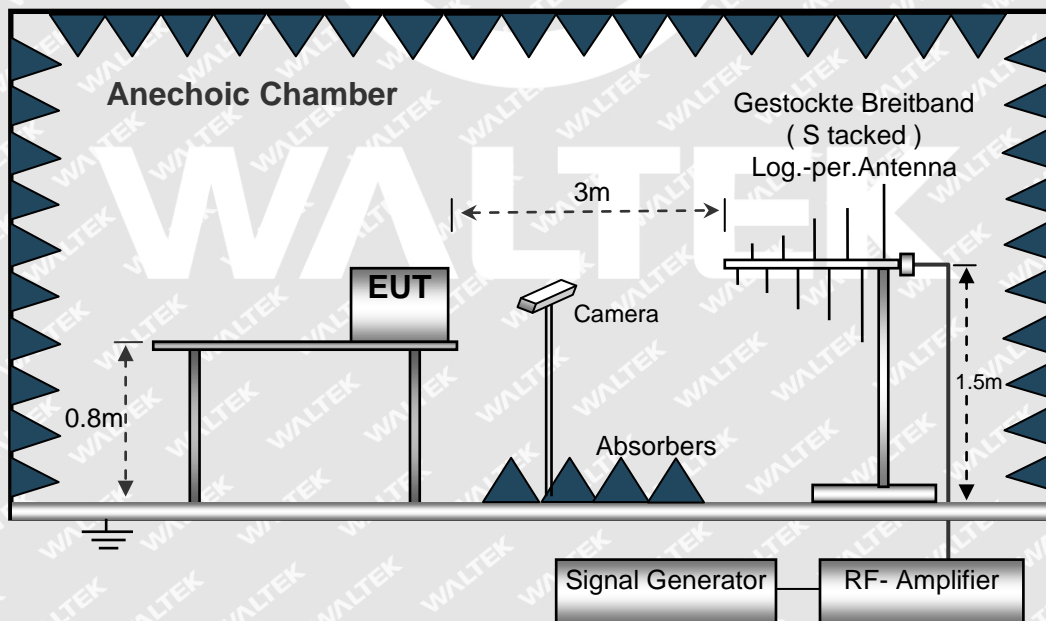



### 7.3.3 Test Result

Frequency	Face of EUT	Antenna polarisation	Test Level	Step Size	Dwell Time	Performance Criterion	Result
80MHz to 1000MHz	Front, Back, Left, Right	Horizontal	3V/m	1%	1s	A	Pass*
80MHz to 1000MHz	Front, Back, Left, Right	Vertical	3V/m	1%	1s	A	Pass*
1000MHz to 6000MHz	Front, Back, Left, Right	Horizontal	3V/m	1%	1s	A	Pass*
1000MHz to 6000MHz	Front, Back, Left, Right	Vertical	3V/m	1%	1s	A	Pass*

Remark:

- \* During the test no deviation was detected to the selected operation mode(s)

# WALTEK



## 8 Health Requirements

### 8.1 Limits

According to Council Recommendation: the criteria listed in the following table shall be used to evaluate the environment impact of human exposure to radio frequency (RF) radiation.

Reference levels for electric, magnetic and electromagnetic fields (10MHz to 300GHz).

Low-power electronic and electrical equipment is deemed to comply with the provisions of this standard if it can be demonstrated using routes B, C or D that the available antenna power and/or the average total radiated power is less than or equal to the applicable low-power exclusion level P<sub>max</sub>.

Annex A contains example values for P<sub>max</sub> derived from existing exposure limits listed in the bibliography, such as the ICNIRP guidelines [1], IEEE Std C95.1-1999 [2], and IEEE Std C95.1-2005 [3].

For wireless devices operated close to a person's body with available antenna powers and/or average total radiated powers higher than the P<sub>max</sub> values given in Annex A, the alternative P<sub>max</sub> values (called P<sub>max</sub>'), described in Annex B can also be used.

For low power equipment using pulsed signals, other limits may apply in addition to those considered in Annex A and Annex B. Both ICNIRP guidelines [1] and IEEE standards [2], [3] have specific restrictions on exposures to pulsed fields, and the requirements of those standards with respect to exposure to pulses shall be met. Annex C discusses this topic further.

### 8.2 Test Result of RF Exposure Evaluation

Test Mode	Transmit
Limit (P <sub>max</sub> )	20mW/13dBm

After performed the test at low/middle/high channel, the below recorded is the worst.

The worst e.i.r.p. (dBm)	P <sub>max</sub> (dBm)	Result
-5.89	13	Complies





## 9 Photographs —Test Setup

### 9.1 Photograph —Spurious Emissions Test Setup

Below 1000MHz



Above 1000MHz





## 9.2 Photograph - Radiated Emissions Test Setup

Below 1000MHz

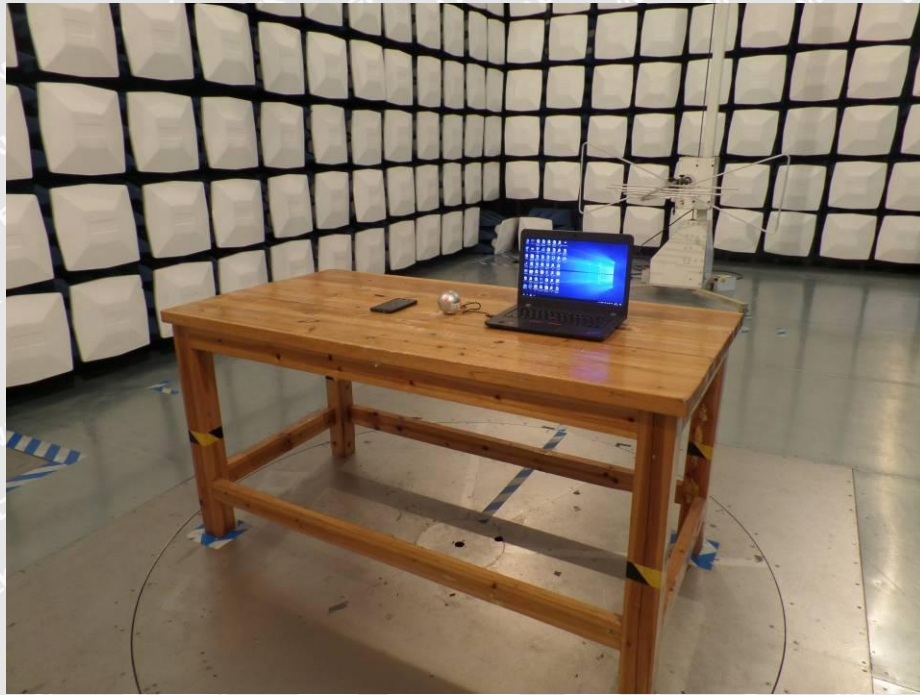

Above 1000MHz







### 9.3 Photograph - RF Electromagnetic Field Test Setup

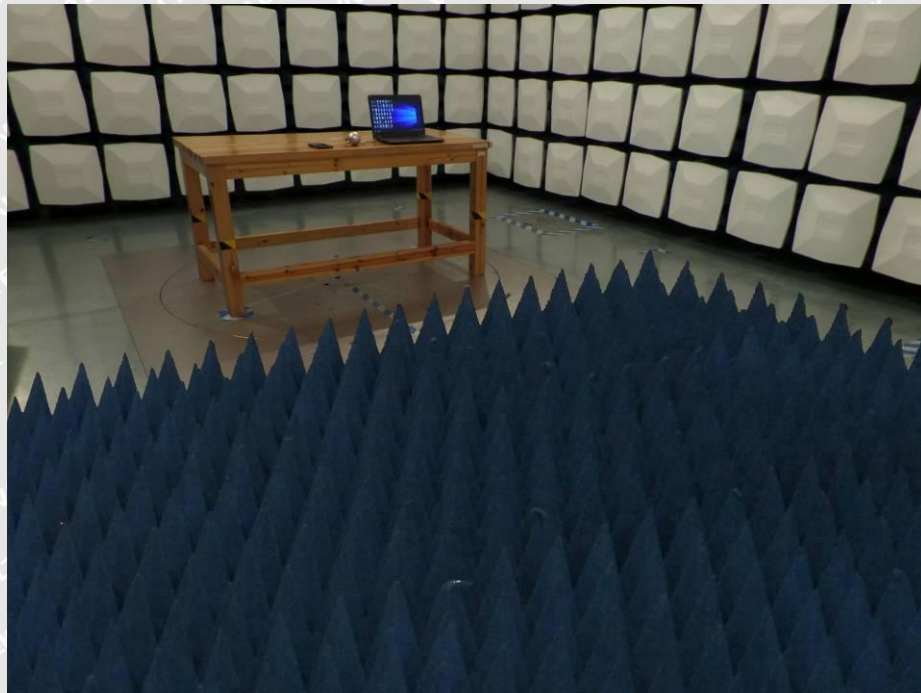

### 9.4 Photograph - ESD Test Setup







## 10 Photographs - Constructional Details

### 10.1 EUT – External Photos



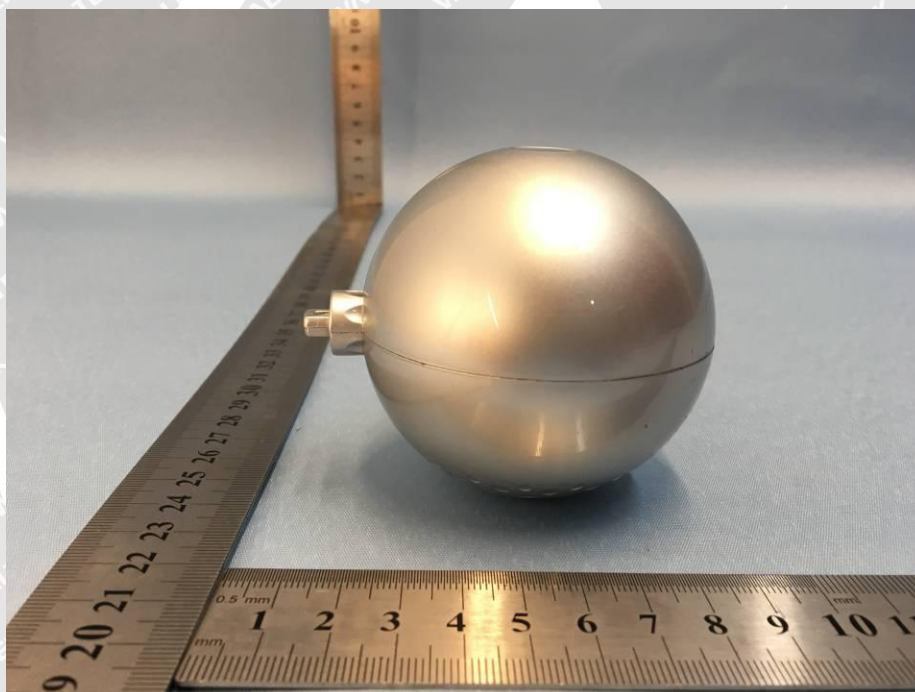
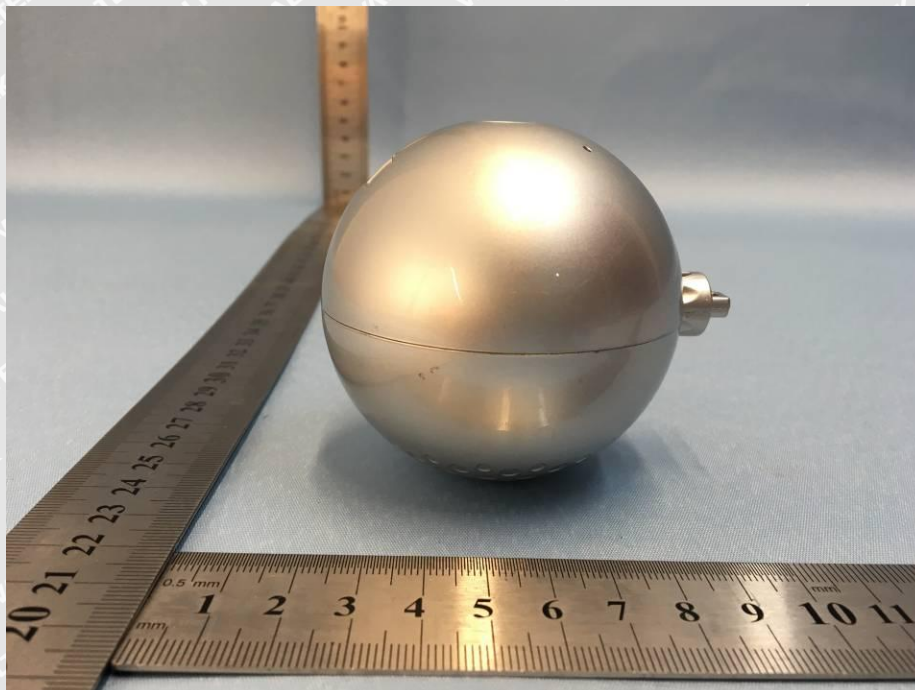



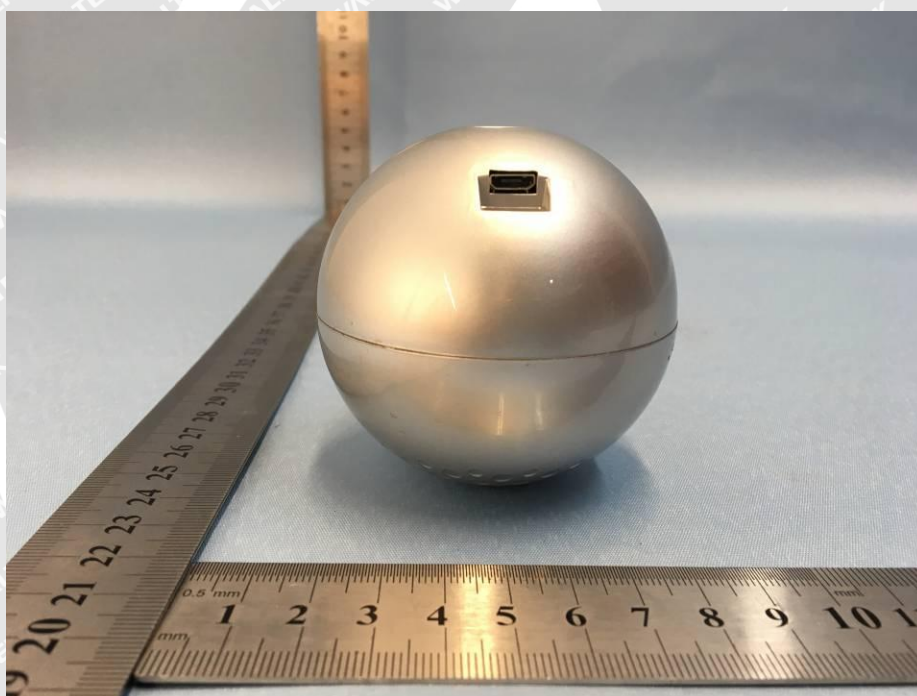
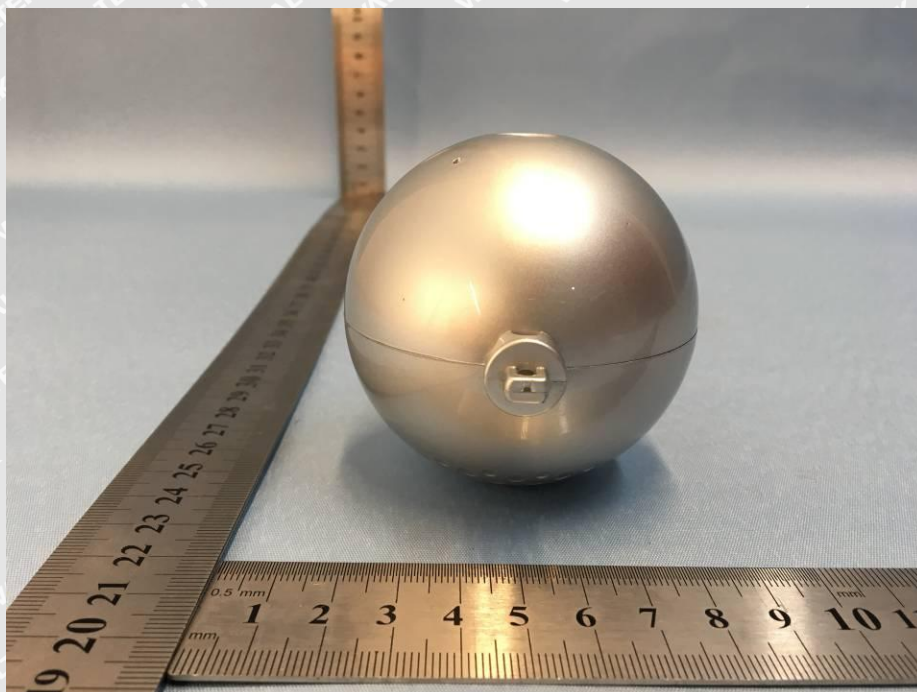





### 10.2 EUT – Internal Photos

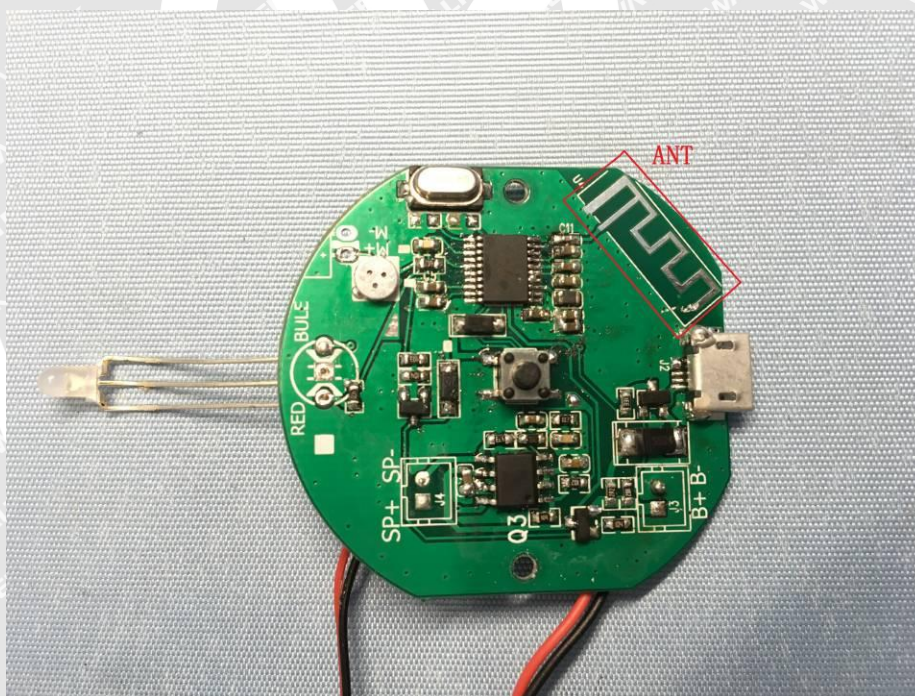
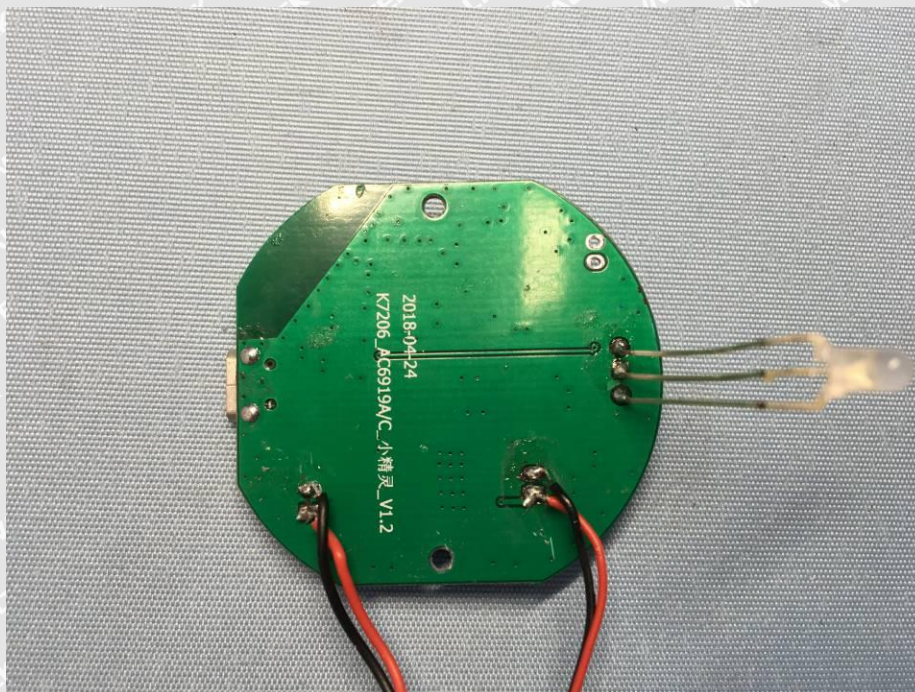



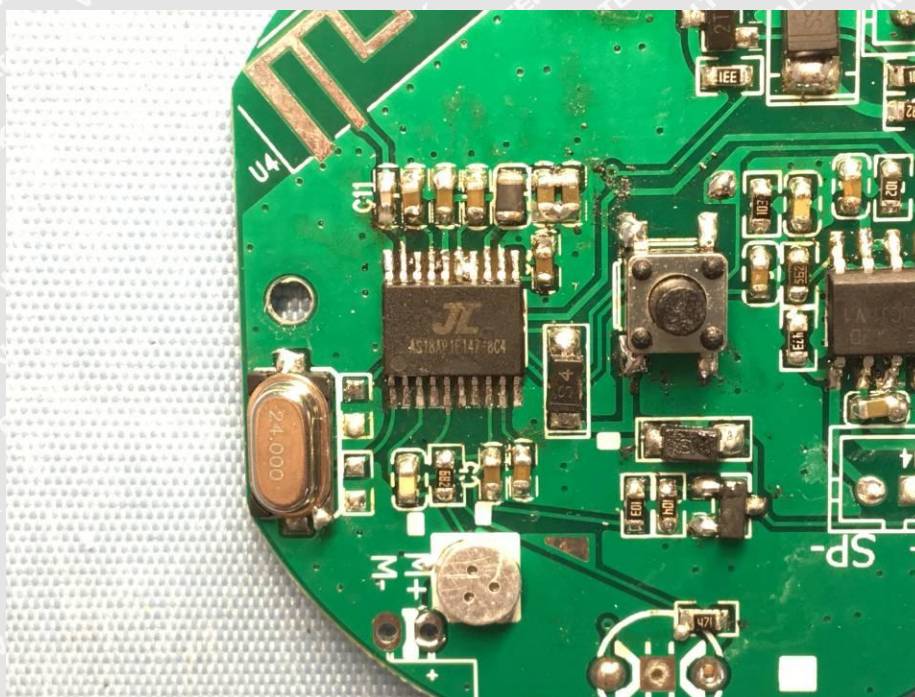

====End of Report====



# WALTEK