



中国认可
国际互认
检测
TESTING
CNAS L3110



TEST REPORT

Reference No. : WTF18F03106886R1E
 Applicant : Mid Ocean Brands B.V.
 Address : Unit 201 2/F., Laford Centre, 838 Lai Chi Kok Road, Cheung Sha
 Wan, Kowloon, Hong Kong
 Manufacturer : 103221
 Product Name : Bluetooth Speaker
 Model No. : CX1449
 Standards : EN 55032:2015
 EN 55024:2010+A1:2015
 Date of Receipt sample : 2018-05-08
 Date of Test : 2018-05-08 to 2018-05-10
 Date of Issue : 2018-05-11
 Test Report Form No. : WEO-55032A-01A
 Test Result : Pass

Remarks:

The results shown in this test report refer only to the sample(s) tested, this test report cannot be reproduced, except in full, without prior written permission of the company. The report would be invalid without specific stamp of test institute and the signatures of compiler and approver.

Prepared By:

Waltek Services (Shenzhen) Co., Ltd.

Address: 1/F., Fukangtai Building, West Baima Road, Songgang Street, Baoan District, Shenzhen,
 Guangdong, China
 Tel :+86-755-83551083
 Fax:+86-755-83552400

Compiled by:

Roy Hong / Project Engineer

Approved by:

Philo Zhong / Manager





1 Test Summary

EMISSION (EN 55032:2015)				
Test Item	Test Standard	Class / Severity	Result	
Radiation Emission, 30MHz to 1000MHz	EN 55032:2015	Table A.4	Pass	
Radiation Emission, 1GHz to 6GHz	EN 55032:2015	Table A.5	Pass	
IMMUNITY (EN 55024:2010+A1:2015)				
Test Item	Test Method	Class / Severity	Performance Criteria	Result
Electrostatic Discharge(ESD)	IEC 61000-4-2:2008	±4 kV Contact ±8 kV Air	B	Pass
Radio-frequency electromagnetic fields (80MHz to 1GHz)	IEC 61000-4-3:2010	3V/m, 80%, 1kHz, Amp. Mod.	A	Pass

Remark:

Pass

Test item meets the requirement

N/A

Test case does not apply to the test object

WALTEK



2 Contents

	Page
COVER PAGE	1
1 TEST SUMMARY	2
2 CONTENTS	3
3 GENERAL INFORMATION	4
3.1 GENERAL DESCRIPTION OF E.U.T.	4
3.2 DETAILS OF E.U.T.	4
3.3 DESCRIPTION OF SUPPORT UNITS	4
3.4 STANDARDS APPLICABLE FOR TESTING	4
3.5 SPECIAL ACCESSORIES AND AUXILIARY EQUIPMENT	4
3.6 SUBCONTRACTED.....	5
3.7 ABNORMALITIES FROM STANDARD CONDITIONS	5
3.8 OTHER.....	5
4 EQUIPMENT USED DURING TEST	6
4.1 MEASUREMENT UNCERTAINTY	6
5 EMISSION TEST RESULTS	7
5.1 RADIATED EMISSION , 30MHZ TO 1000MHZ.....	7
5.1.1 <i>E.U.T. Operation</i>	7
5.1.2 <i>Block Diagram of Test Setup</i>	7
5.1.3 <i>Radiated Emission Test Data</i>	8
5.2 RADIATED EMISSION ,1GHZ TO 6GHZ.....	12
5.2.1 <i>E.U.T. Operation</i>	12
5.2.2 <i>Block Diagram of Test Setup</i>	12
5.2.3 <i>Radiated Emission Test Data</i>	13
6 IMMUNITY TEST RESULTS	17
6.1 PERFORMANCE CRITERIA	17
6.2 ELECTROSTATIC DISCHARGE(ESD).....	18
6.2.1 <i>E.U.T. Operation</i>	18
6.2.2 <i>Block Diagram of Test Setup</i>	18
6.2.3 <i>Direct Discharge Test Results</i>	19
6.2.4 <i>Indirect Discharge Test Results</i>	19
6.3 RADIO-FREQUENCY ELECTROMAGNETIC FIELDS, 80MHZ TO 1GHZ	20
6.3.1 <i>E.U.T. Operation</i>	20
6.3.2 <i>Block Diagram of Setup</i>	20
6.3.3 <i>Test Results</i>	21
7 PHOTOGRAPHS – TEST SETUP	22
7.1 PHOTOGRAPH –RADIATED EMISSION TEST SETUP, 30MHZ TO 1GHZ	22
7.2 PHOTOGRAPH –RADIATED EMISSION TEST SETUP, 1GHZ TO 6GHZ	22
7.3 PHOTOGRAPH –ESD TEST SETUP	23
7.4 PHOTOGRAPH - RADIATED IMMUNITY TEST SETUP	23
8 PHOTOGRAPHS – CONSTRUCTIONAL DETAILS	24
8.1 EUT – FRONT VIEW.....	24
8.2 EUT – INTERNAL VIEW	25



3 General Information

3.1 General Description of E.U.T.

Product Name : Bluetooth Speaker
 Model No. : CX1449
 Remark..... : ---

3.2 Details of E.U.T.

Technical Data : Battery 3.7V or DC 5V by USB port

3.3 Description of Support Units

The EUT has been tested as an independent unit. CX1449 is the test sample. All tests were performed in the condition of DC 5V input with Notebook powered by USB port or battery 3.7V input.

3.4 Standards Applicable for Testing

The tests were performed according to following standards:

EN 55032:2015 Electromagnetic compatibility of multimedia equipment — Emission Requirements
 EN 55024:2010+A1:2015 Information technology equipment — Immunity characteristics — Limits and methods of measurement.

3.5 Special Accessories and Auxiliary Equipment

Item	Equipment	Technical Data	Manufacturer	Model No.	Serial No.
1.	Notebook	AC 230V/50Hz	Lenovo	ThinkPad Edge E430	00426-OEM-8992662-00400



3.6 Subcontracted

Whether parts of tests for the product have been subcontracted to other labs:

Yes No

If Yes, list the related test items and lab information:

Test items: ---

Lab information: ---

3.7 Abnormalities from Standard Conditions

None.

3.8 Other

This report is based on project No. WTF18F03106886E for changing PCB board. It may possibly affect the full EMC test items. Therefore the full EMC tests: RE, ESD, RS were performed on model CX1449 with new PCB board.



WALTEK



4 Equipment Used during Test

3m Semi-anechoic Chamber for Radiation					
Item	Equipment	Manufacturer	Model No.	Serial No.	Calibration Status
1.	EMI Test Receiver	R&S	ESCI	101296	Valid
2.	Trilog Broadband Antenna	SCHWARZBECK	VULB9160	9160-3325	Valid
3.	Amplifier	Compliance pirection systems inc	PAP-0203	22024	Valid
4.	Cable	HUBER+SUHNER	CBL2	525178	Valid
ESD					
Item	Equipment	Manufacturer	Model No.	Serial No.	Calibration Status
1.	Electrostatic Discharge Simulator	Em Test	DITO	V0745103094	Valid
Radio-frequency electromagnetic fields					
Item	Equipment	Manufacturer	Model No.	Serial No.	Calibration Status
1.	Signal Generater	R&S	SMB100A	105942	Valid
2.	RF Power Amplifier	BONN Elektronik	BLWA0830-160/100/40D	128740	Valid
3.	Gestockte Breitband (S tacked) Log.-per.Antenna	SCHWARZBECK	STLP9128D	043	Valid
4.	Power Meter	R&S	NRP2	102031	Valid

4.1 Measurement Uncertainty

Test Item	Frequency Range	Uncertainty	Note
Conducted Emission	150kHz~30MHz	±2.66dB	(1)
Radiated Emission	30MHz~1000MHz	±5.03dB	(1)
Radiated Emission	1GHz ~ 6GHz	±5.47dB	(1)

(1)This uncertainty represents an expanded uncertainty expressed at approximately the 95% confidence level using a coverage factor of $k=2$.



5 Emission Test Results

5.1 Radiated Emission , 30MHz to 1000MHz

Test Requirement.....	: EN 55032
Test Method.....	: EN 55032
Test Limit	: Table A.4 of EN 55032
Test Result.....	: Pass
Frequency Range.....	: 30MHz to 1000MHz
Class.....	: Class B

5.1.1 E.U.T. Operation

Operating Environment:

Temperature	: 23.5°C
Humidity.....	: 48.3%RH
Atmospheric Pressure.....	: 101.2 kPa

EUT Operation:

Input Voltage	: DC 5V by USB port, or battery 3.7V
Operating Mode.....	: Bluetooth+ charging mode, or Bluetooth+ discharging mode

5.1.2 Block Diagram of Test Setup

The Radiated Emission tests were performed in the 3m Semi- Anechoic Chamber test site, using the setup accordance with the CISPR 16-2-3.

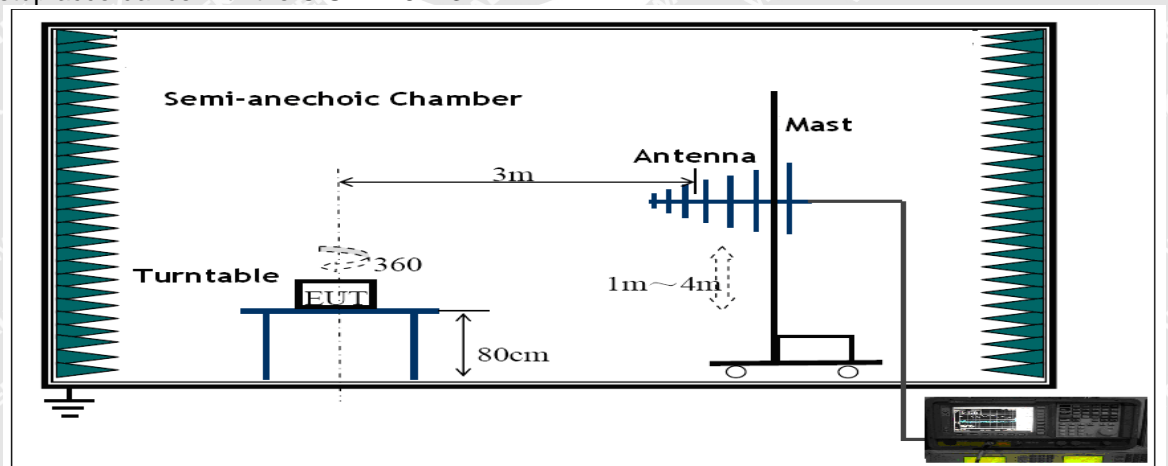



5.1.3 Radiated Emission Test Data

According to the data in section 5.2.4, the EUT complied with the EN 55032 standards.

Vertical Polarization (Bluetooth+ charging mode):

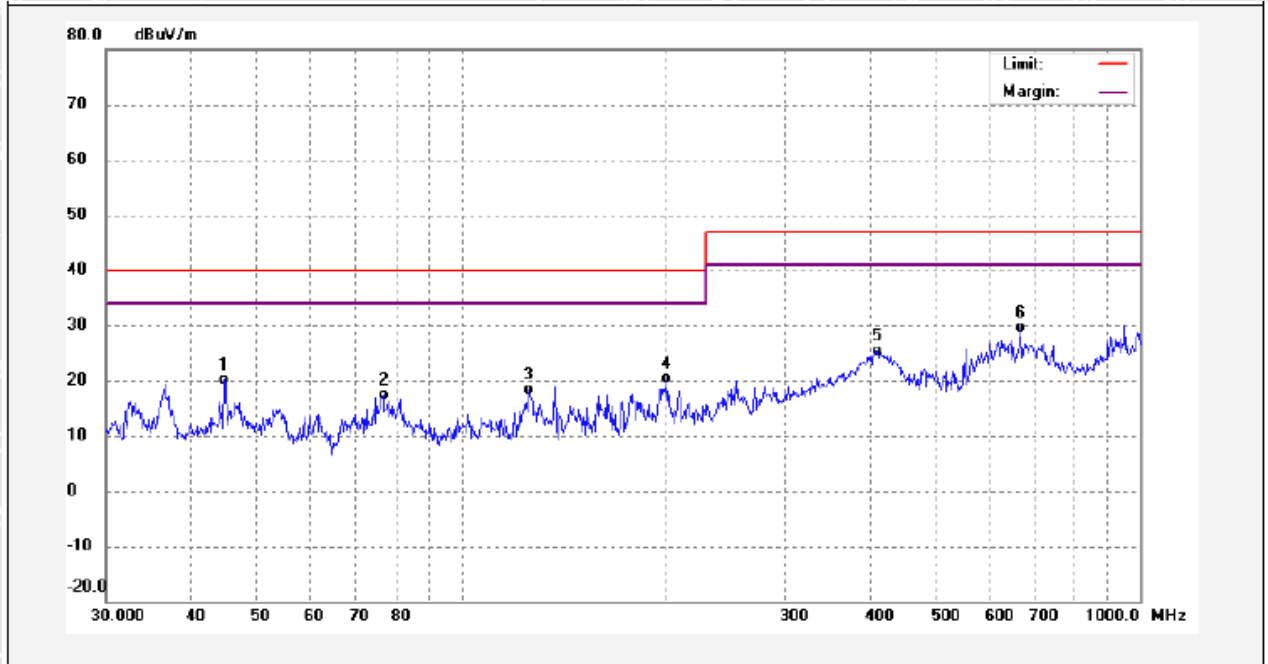

No.	Freq. (MHz)	Reading (dBuV/m)	Factor (dB)	Result (dBuV/m)	Limit (dBuV/m)	Margin (dB)	Detector	Remark
1	44.7433	32.72	-12.62	20.10	40.00	-19.90	QP	
2	76.7808	37.36	-20.08	17.28	40.00	-22.72	QP	
3	125.8864	35.44	-17.16	18.28	40.00	-21.72	QP	
4	200.6881	36.79	-16.47	20.32	40.00	-19.68	QP	
5	410.3825	34.09	-8.67	25.42	47.00	-21.58	QP	
6	665.8035	32.61	-2.91	29.70	47.00	-17.30	QP	





Horizontal Polarization (Bluetooth+ charging mode):

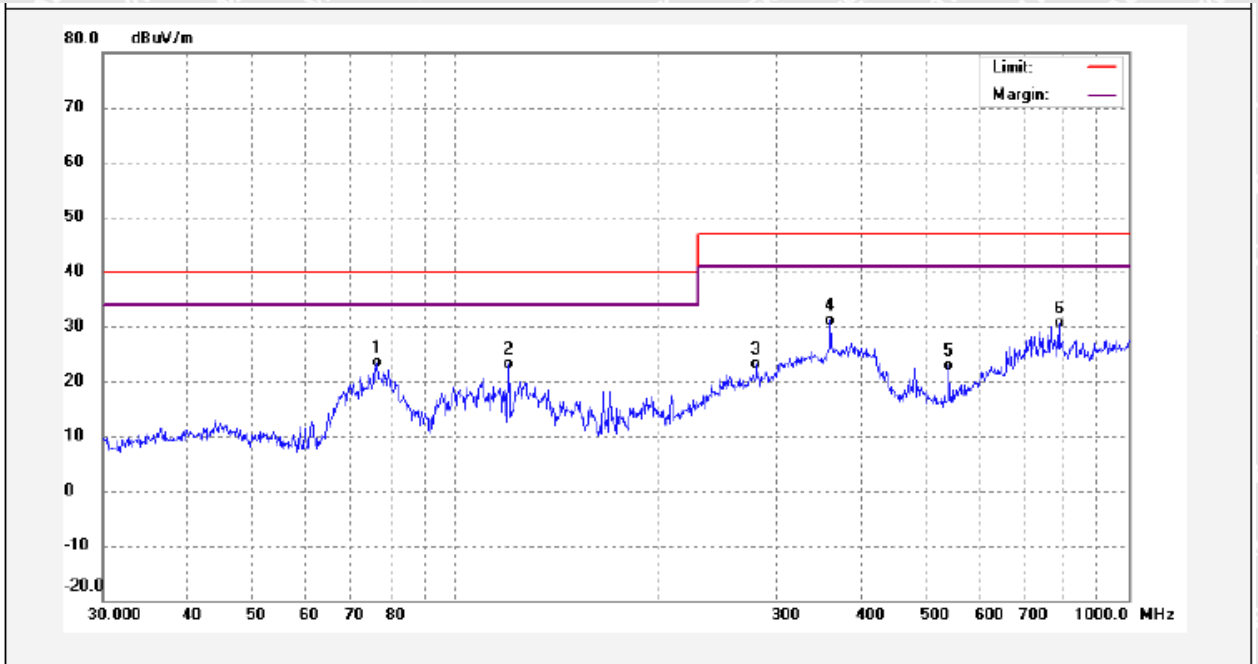

No.	Freq. (MHz)	Reading (dBuV/m)	Factor (dB)	Result (dBuV/m)	Limit (dBuV/m)	Margin (dB)	Detector	Remark
1	76.5121	43.45	-20.02	23.43	40.00	-16.57	QP	
2	119.8556	39.83	-16.58	23.25	40.00	-16.75	QP	
3	280.0237	35.98	-12.88	23.10	47.00	-23.90	QP	
4	360.4476	39.98	-8.87	31.11	47.00	-15.89	QP	
5	541.3725	31.07	-8.11	22.96	47.00	-24.04	QP	
6	787.8513	33.87	-3.26	30.61	47.00	-16.39	QP	





Vertical Polarization (Bluetooth+ discharging mode):

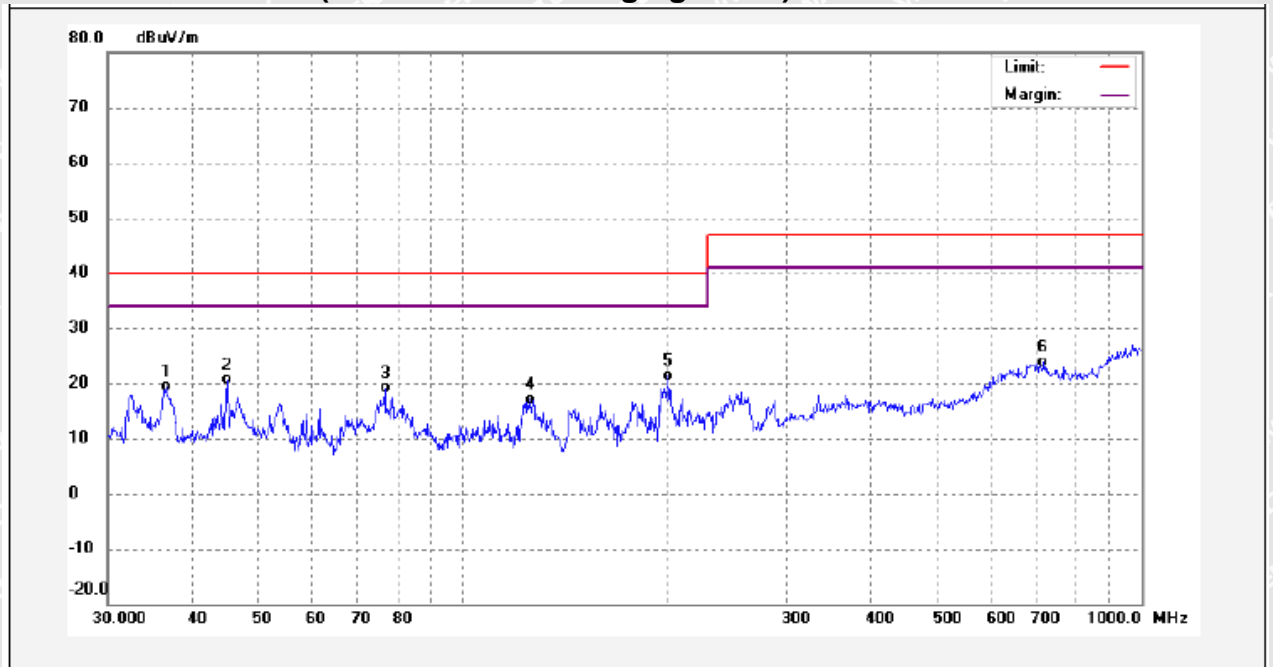

No.	Freq. (MHz)	Reading (dBuV/m)	Factor (dB)	Result (dBuV/m)	Limit (dBuV/m)	Margin (dB)	Detector	Remark
1	36.5092	33.87	-14.55	19.32	40.00	-20.68	QP	
2	44.9006	33.41	-12.66	20.75	40.00	-19.25	QP	
3	76.7808	39.24	-20.08	19.16	40.00	-20.84	QP	
4	125.4457	34.19	-17.10	17.09	40.00	-22.91	QP	
5	200.6881	37.75	-16.47	21.28	40.00	-18.72	QP	
6	716.6820	25.79	-1.99	23.80	47.00	-23.20	QP	

WALTEK



Horizontal Polarization (Bluetooth+ discharging mode):

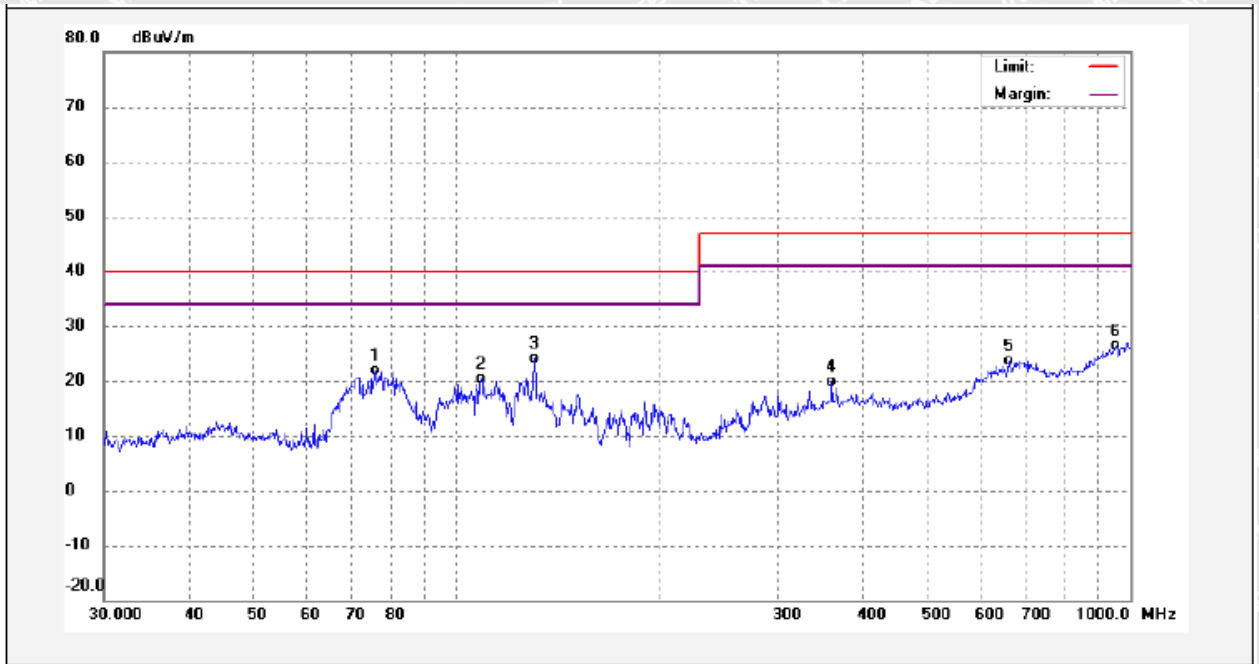

No.	Freq. (MHz)	Reading (dBuV/m)	Factor (dB)	Result (dBuV/m)	Limit (dBuV/m)	Margin (dB)	Detector	Remark
1	75.7114	41.83	-20.01	21.82	40.00	-18.18	QP	
2	108.6470	36.43	-16.05	20.38	40.00	-19.62	QP	
3	130.3789	41.88	-17.75	24.13	40.00	-15.87	QP	
4	360.4476	28.84	-8.87	19.97	47.00	-27.03	QP	
5	661.1505	26.63	-3.00	23.63	47.00	-23.37	QP	
6	952.0937	25.08	1.24	26.32	47.00	-20.68	QP	





5.2 Radiated Emission ,1GHz to 6GHz

Test Requirement.....	: EN 55032
Test Method.....	: EN 55032
Test Limit.....	: Table A.5 of EN 55032
Test Result.....	: Pass
Frequency Range.....	: 1GHz to 6GHz
Class.....	: Class B

5.2.1 E.U.T. Operation

Operating Environment:

Temperature	: 23.5°C
Humidity.....	: 48.3%RH
Atmospheric Pressure.....	: 101.2 kPa

EUT Operation:

Input Voltage	: DC 5V by USB port, or battery 3.7V
Operating Mode.....	: Bluetooth+ charging mode, or Bluetooth+ discharging mode

5.2.2 Block Diagram of Test Setup

The Radiated Emission tests were performed in the 3m Semi- Anechoic Chamber test site, using the setup accordance with the CISPR 16-2-3.

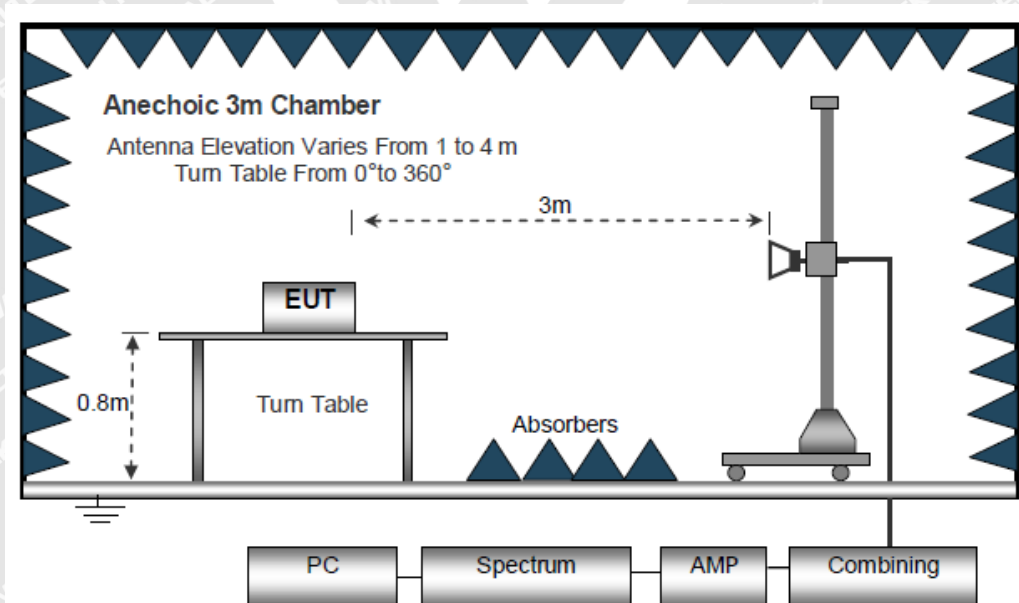



5.2.3 Radiated Emission Test Data

According to the data in section 5.2.4, the EUT complied with the EN 55032 standards.

Vertical Polarization (Bluetooth+ charging mode):

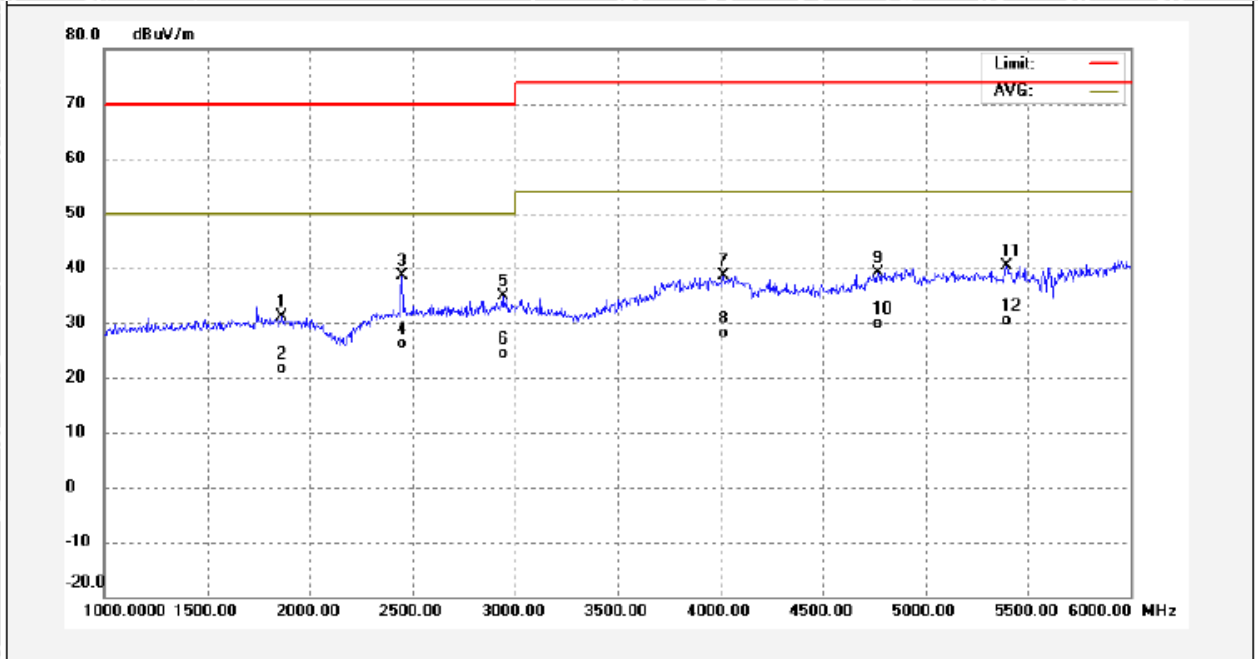

No.	Freq. (MHz)	Reading (dBuV/m)	Factor (dB)	Result (dBuV/m)	Limit (dBuV/m)	Margin (dB)	Detector	Remark
1	1865.000	46.00	-14.87	31.13	70.00	-38.87	peak	
2	1865.000	36.44	-14.87	21.57	50.00	-28.43	AVG	
3	2450.000	51.23	-12.70	38.53	70.00	-31.47	peak	
4	2450.000	38.89	-12.70	26.19	50.00	-23.81	AVG	
5	2940.000	46.43	-11.48	34.95	70.00	-35.05	peak	
6	2940.000	35.77	-11.48	24.29	50.00	-25.71	AVG	
7	4015.000	47.35	-8.70	38.65	74.00	-35.35	peak	
8	4015.000	36.71	-8.70	28.01	54.00	-25.99	AVG	
9	4770.000	45.59	-6.51	39.08	74.00	-34.92	peak	
10	4770.000	36.42	-6.51	29.91	54.00	-24.09	AVG	
11	5395.000	45.82	-5.39	40.43	74.00	-33.57	peak	
12	5395.000	35.87	-5.39	30.48	54.00	-23.52	AVG	



Horizontal Polarization (Bluetooth+ charging mode):

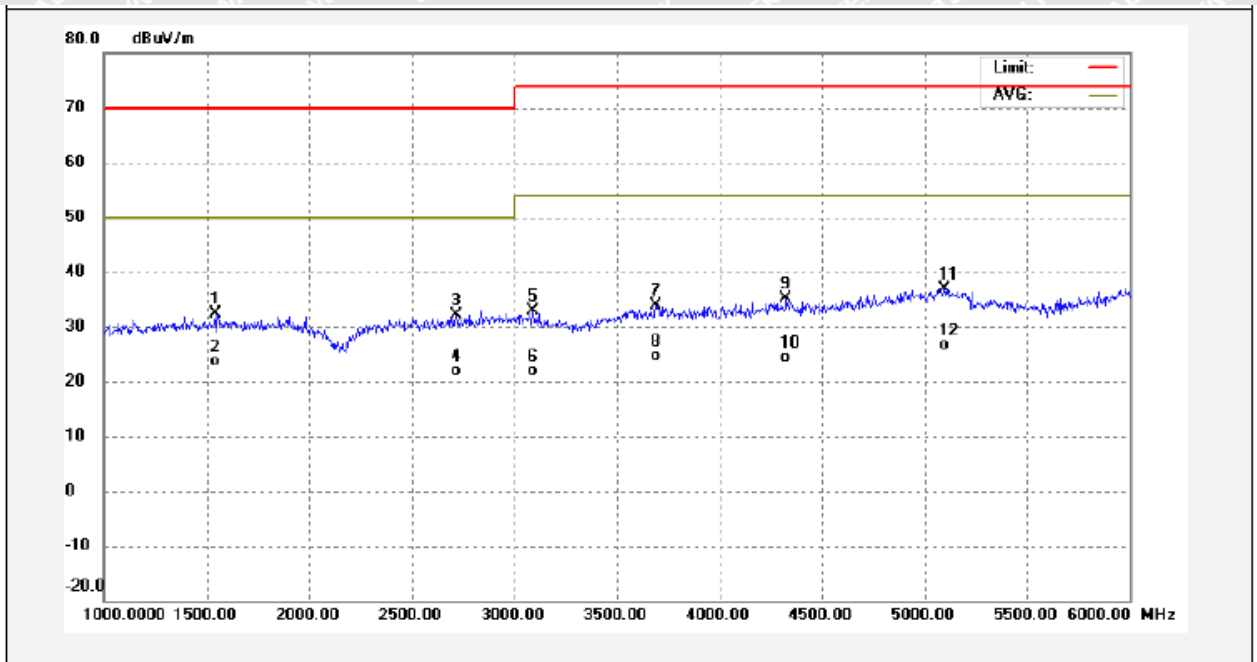

No.	Freq. (MHz)	Reading (dBuV/m)	Factor (dB)	Result (dBuV/m)	Limit (dBuV/m)	Margin (dB)	Detector	Remark
1	1540.000	48.04	-15.78	32.26	70.00	-37.74	peak	
2	1540.000	39.46	-15.78	23.68	50.00	-26.32	AVG	
3	2715.000	46.35	-14.12	32.23	70.00	-37.77	peak	
4	2715.000	35.99	-14.12	21.87	50.00	-28.13	AVG	
5	3090.000	46.00	-13.18	32.82	74.00	-41.18	peak	
6	3090.000	35.06	-13.18	21.88	54.00	-32.12	AVG	
7	3690.000	46.15	-12.28	33.87	74.00	-40.13	peak	
8	3690.000	36.90	-12.28	24.62	54.00	-29.38	AVG	
9	4325.000	46.27	-11.21	35.06	74.00	-38.94	peak	
10	4325.000	35.54	-11.21	24.33	54.00	-29.67	AVG	
11	5095.000	46.44	-9.56	36.88	74.00	-37.12	peak	
12	5095.000	36.24	-9.56	26.68	54.00	-27.32	AVG	



Vertical Polarization (Bluetooth+ discharging mode):

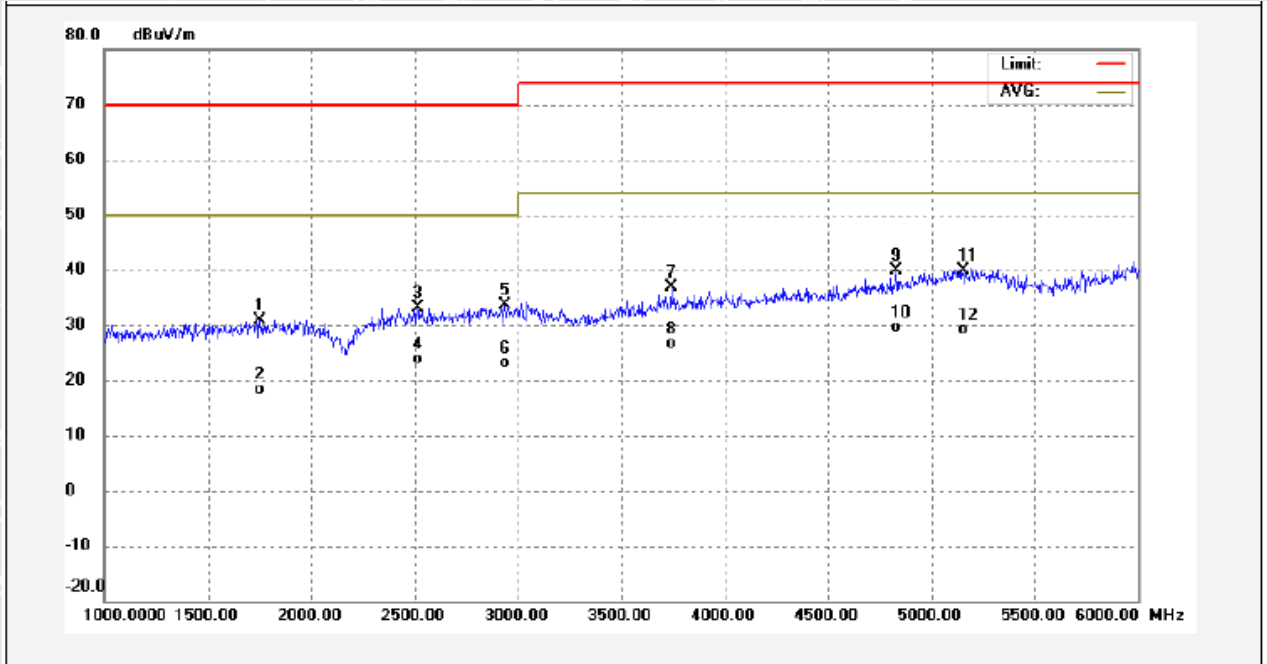

No.	Freq. (MHz)	Reading (dBuV/m)	Factor (dB)	Result (dBuV/m)	Limit (dBuV/m)	Margin (dB)	Detector	Remark
1	1750.000	46.07	-15.17	30.90	70.00	-39.10	peak	
2	1750.000	33.63	-15.17	18.46	50.00	-31.54	AVG	
3	2515.000	45.67	-12.47	33.20	70.00	-36.80	peak	
4	2515.000	36.39	-12.47	23.92	50.00	-26.08	AVG	
5	2935.000	45.03	-11.50	33.53	70.00	-36.47	peak	
6	2935.000	34.67	-11.50	23.17	50.00	-26.83	AVG	
7	3740.000	46.58	-9.63	36.95	74.00	-37.05	peak	
8	3740.000	36.32	-9.63	26.69	54.00	-27.31	AVG	
9	4830.000	46.17	-6.23	39.94	74.00	-34.06	peak	
10	4830.000	35.76	-6.23	29.53	54.00	-24.47	AVG	
11	5155.000	45.44	-5.45	39.99	74.00	-34.01	peak	
12	5155.000	34.60	-5.45	29.15	54.00	-24.85	AVG	



Horizontal Polarization (Bluetooth+ discharging mode):

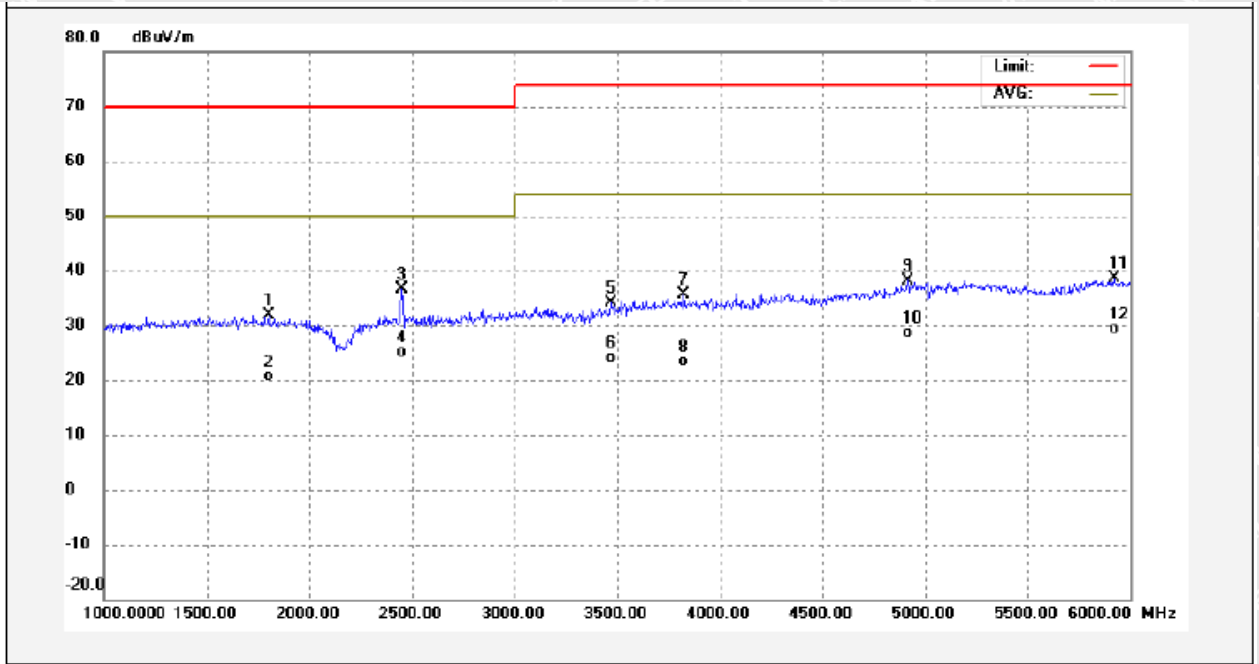

No.	Freq. (MHz)	Reading (dBuV/m)	Factor (dB)	Result (dBuV/m)	Limit (dBuV/m)	Margin (dB)	Detector	Remark
1	1800.000	47.55	-15.63	31.92	70.00	-38.08	peak	
2	1800.000	36.21	-15.63	20.58	50.00	-29.42	AVG	
3	2450.000	51.29	-14.78	36.51	70.00	-33.49	peak	
4	2450.000	39.96	-14.78	25.18	50.00	-24.82	AVG	
5	3470.000	46.71	-12.61	34.10	74.00	-39.90	peak	
6	3470.000	36.70	-12.61	24.09	54.00	-29.91	AVG	
7	3825.000	47.82	-12.10	35.72	74.00	-38.28	peak	
8	3825.000	35.39	-12.10	23.29	54.00	-30.71	AVG	
9	4915.000	48.07	-9.82	38.25	74.00	-35.75	peak	
10	4915.000	38.54	-9.82	28.72	54.00	-25.28	AVG	
11	5920.000	46.54	-8.03	38.51	74.00	-35.49	peak	
12	5920.000	37.43	-8.03	29.40	54.00	-24.60	AVG	



6 Immunity Test Results

6.1 Performance Criteria

Performance criterion A: The apparatus shall continue to operate as intended during the test. No degradation of performance or loss of function is allowed below a performance level (or permissible loss of performance) specified by the manufacturer, when the apparatus is used as intended. If the minimum performance level or the permissible performance loss is not specified by the manufacturer, then either of these may be derived from the product description and documentation, and from what the user may reasonably expect from the apparatus if used as intended.

Performance criterion B: The apparatus shall continue to operate as intended after the test. No degradation of performance or loss of function is allowed below a performance level (or permissible loss of performance) specified by the manufacturer, when the apparatus is used as intended. During the test, degradation of performance is allowed, however, no change of actual operating state or stored data is allowed. If the minimum performance level or the permissible performance loss is not specified by the manufacturer, then either of these may be derived from the product description and documentation, and from what the user may reasonably expect from the apparatus if used as intended.

Performance criterion C: Temporary loss of function is allowed, provided the function is self-recoverable or can be restored by the operation of the controls, or by any operation specified in the instructions for use.

For further details, please refer to EN 55024.



WALTEK



6.2 Electrostatic Discharge(ESD)

Test Requirement.....	:	EN 55024
Test Method.....	:	IEC 61000-4-2
Test Result	:	Pass
Discharge Impedance.....	:	330Ω / 150pF
Discharge Voltage	:	Air Discharge: ±8kV Contact Discharge: ±4kV HCP & VCP: ±4kV
Polarity.....	:	Positive & Negative
Number of Discharge.....	:	Minimum 10 times at each test point
Discharge Mode	:	Single Discharge
Discharge Period	:	1 second minimum

6.2.1 E.U.T. Operation

Operating Environment:

Temperature.....	:	19.5°C
Humidity.....	:	50.3%RH
Atmospheric Pressure	:	100.2kPa

EUT Operation:

Input Voltage.....	:	Battery 3.7V ; DC 5V by USB port
Operating Mode.....	:	Bluetooth mode; Bluetooth + charging mode

6.2.2 Block Diagram of Test Setup

The ESD test was performed in accordance with the IEC 61000-4-2.

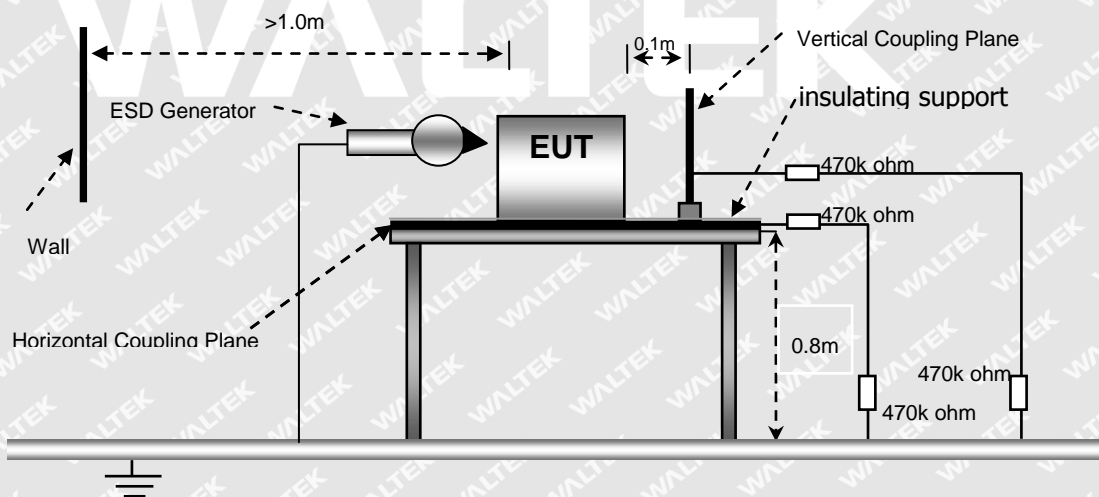



6.2.3 Direct Discharge Test Results

Observations : Test points : 1. All Exposed Surface & Seams;
2. All metallic part

Direct Discharge			Test Results	
Applied Voltage (kV)	Performance Criterion	Test Point	Contact Discharge	Air Discharge
±8	B	1	N/A	Pass*
±4	B	2	Pass*	N/A

Remark: * During the test no deviation was detected to the selected operation mode(s)

6.2.4 Indirect Discharge Test Results

Observations : Test points : 1. All sides.

Indirect Discharge			Test Results	
Applied Voltage (kV)	Performance Criterion	Test Point	Horizontal Coupling	Vertical Coupling
±4	B	1	Pass*	Pass*

Remark: * During the test no deviation was detected to the selected operation mode(s)

WALTEK



6.3 Radio-frequency electromagnetic fields, 80MHz to 1GHz

Test Requirement	: EN 55024
Test Method	: IEC 61000-4-3
Test Result	: Pass
Frequency Range	: 80MHz to 1GHz
Test level	: 3V/m
Modulation	: 80%, 1kHz Amplitude Modulation.
Face of EUT	: Front, Back, Left, Right
Antenna polarisation ..	: Horizontal & Vertical

6.3.1 E.U.T. Operation

Operating Environment:

Temperature	: 20.2°C
Humidity	: 51.3%RH
Barometric Pressure	: 100.2kPa

EUT Operation:

Input Voltage	: Battery 3.7V ; DC 5V by USB port
Operating Mode	: Bluetooth mode; Bluetooth + charging mode

6.3.2 Block Diagram of Setup

The Radio-frequency electromagnetic fields Immunity test was performed in accordance with the IEC 61000-4-3.

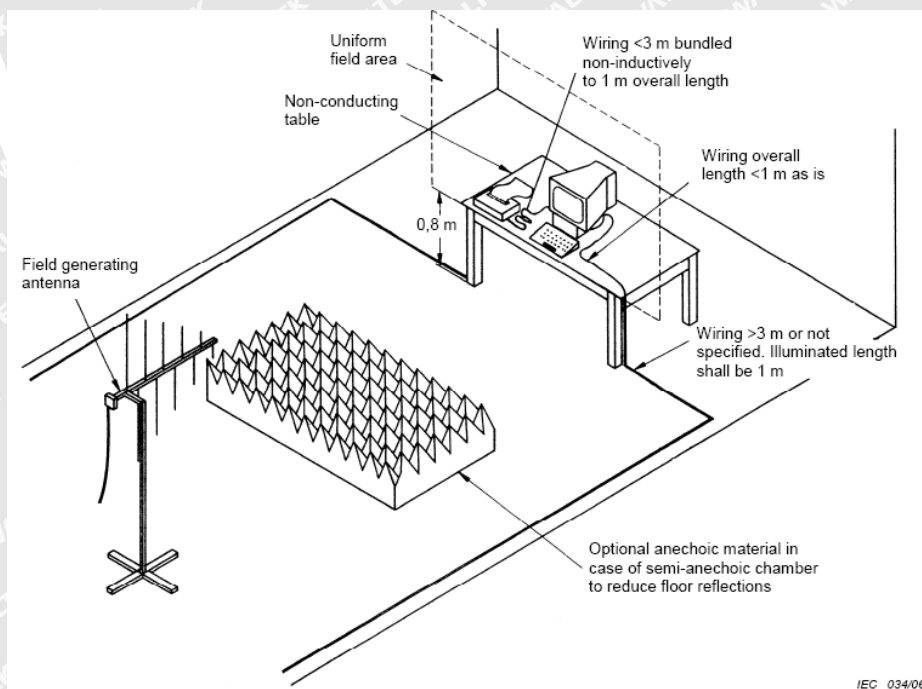



6.3.3 Test Results

Frequency	Face of EUT	Antenna polarisation	Test Level	Step Size	Dwell Time	Performance Criterion	Result
80 to 1000MHz	Front, Back, Left, Right	Horizontal	3V/m	1%	1s	A	Pass*
80 to 1000MHz	Front, Back, Left, Right	Vertical	3V/m	1%	1s	A	Pass*

Remark:

- * During the test no deviation was detected to the selected operation mode(s)



WALTEK



7 Photographs – Test Setup

7.1 Photograph –Radiated Emission Test Setup, 30MHz to 1GHz

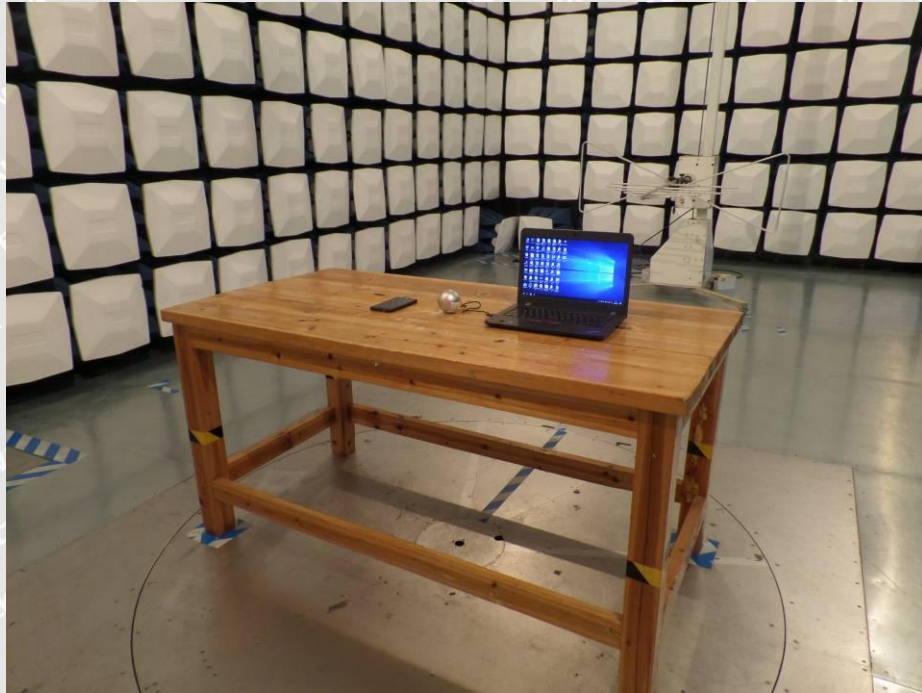

7.2 Photograph –Radiated Emission Test Setup, 1GHz to 6GHz





7.3 Photograph –ESD Test Setup



7.4 Photograph - Radiated immunity Test Setup

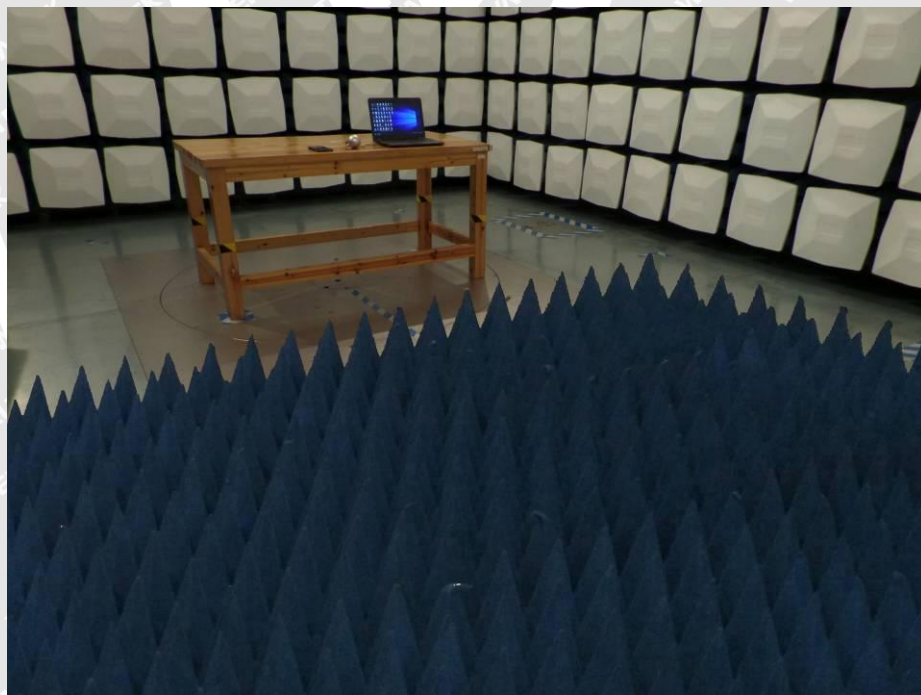



8 Photographs – Constructional Details

8.1 EUT – Front View





8.2 EUT – Internal View

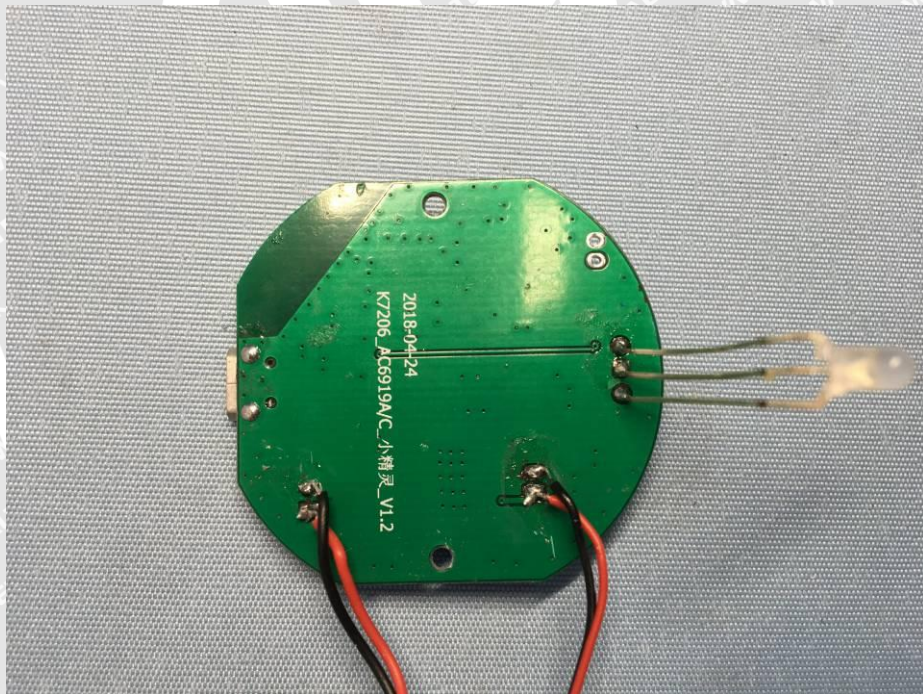
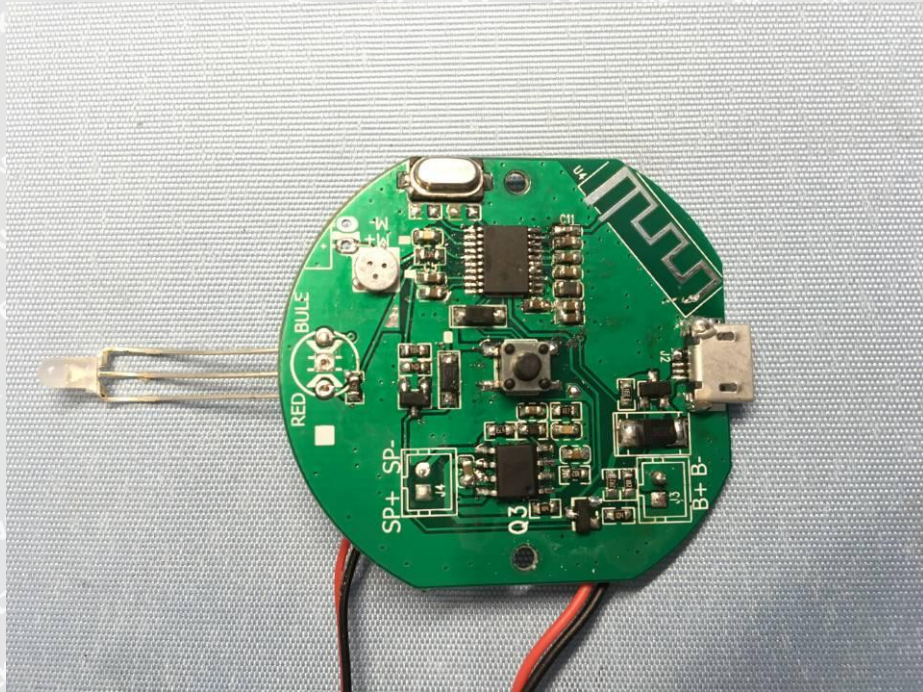

===== End of Report =====