

Test Report

Report No. : TCT170614C008

Date : Jun. 16, 2017

Page No.: 1 of 3

Applicant:

Address:

The following sample was submitted and identified by/on behalf of the client as:

Sample Name: Li-ion Battery

Model No.: 602040

Manufacturer:

Address:

Sample Received Date: 2017.06.14

Testing Period: 2017.06.14—2017.06.16

Test Requested: Accordance with Directive 2006/66/EC, to determine the Lead (Pb), Cadmium (Cd), Mercury (Hg) contents of the submitted sample(s).

Test Method: Please refer to the following page(s).

Test Result(s): Please refer to the following page(s).

Conclusion: Test results of submitted sample(s) comply with the limit set by Directive 2006/66/EC and its amendment 2013/56/EU.

Checked by

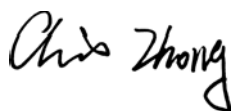

Chris Zhong

Signed for and on behalf of TCT

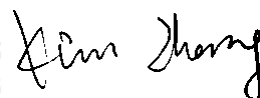

Kim Zhang
Technical Manager



Test Report

Report No. : TCT170614C008

Date : Jun. 16, 2017

Page No.: 2 of 3

Test Results:

Lead, Cadmium and Mercury Content(s)

| Test Items | Test Method | Unit | Test Results | MDL | Labelling Requirement# | Permissible Limit |
|--------------|--|------|--------------|--------|------------------------|-------------------|
| Lead (Pb) | With reference to GB/T 20155-2006, Analysis was performed by ICP-OES | % | N.D. | 0.0010 | > 0.004 | -- |
| Cadmium (Cd) | | | N.D. | 0.0010 | > 0.002 | 0.002## |
| Mercury (Hg) | | | N.D. | 0.0001 | > 0.0005 | 0.0005 |

- Note :
- MDL = Method Detection Limit
 - N.D. = Not detected, less than MDL.
 - # = According to the article 21.3, batteries, accumulators and button cells containing more than 0,0005 % mercury, more than 0,002 % cadmium or more than 0,004 % lead, shall be marked with the chemical symbol for the metal concerned: Hg, Cd or Pb.
 - ## = Not apply to portable batteries and accumulators intended for use in:
 - (a) emergency and alarm systems, including emergency lighting;
 - (b) medical equipment; or
 - (c) cordless power tools.
 - Results shown is/are of total weight of the battery sample.
 - "--" = Not Regulated.
 - According to the article 21.1, all batteries, accumulators and battery packs should be appropriately marked with the crossed-out wheeled bin symbol.

Test Process :

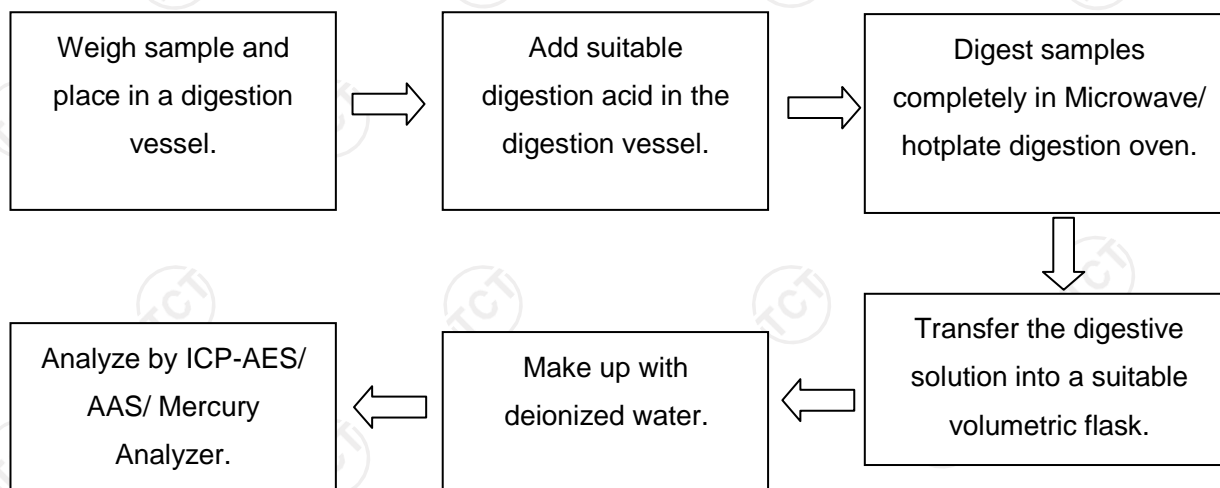

Test Report

Report No. : TCT170614C008

Date : Jun. 16, 2017

Page No.: 3 of 3

Photo(s) of the sample(s)

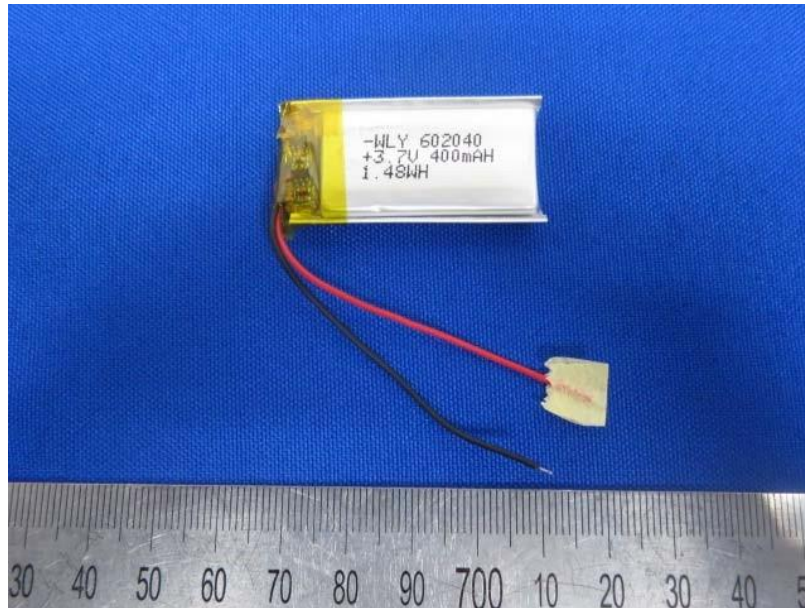

***** End of Report *****

Remark : This report is considered invalidated without the Special Seal for Inspection of the TCT. This report shall not be altered, increased or deleted. The results shown in this test report refer only to the sample(s) tested. Without written approval of TCT, this test report shall not be copied except in full and published as advertisement.



Ref. Certif. No.

JPTUV-084482

IEC SYSTEM FOR MUTUAL RECOGNITION OF TEST CERTIFICATES FOR ELECTRICAL EQUIPMENT (IECEE) CB SCHEME

SYSTEME CEI D'ACCEPTATION MUTUELLE DE CERTIFICATS D ESSAIS DES EQUIPEMENTS ELECTRIQUES (IECEE) METHODE OC

CB TEST CERTIFICATE

CERTIFICAT D'ESSAI OC

Product
Produit

Li-ion Battery

Name and address of the applicant
Nom et adresse du demandeur

Name and address of the manufacturer
Nom et adresse du fabricant

Name and address of the factory
Nom et adresse de l'usine

Ratings and principal characteristics
Valeurs nominales et caractéristiques principales

3.7V, 400mAh, 1.48Wh

Trademark (if any)
Marque de fabrique (si elle existe)

Type of Manufacturer's Testing Laboratories used
Type de programme du laboratoire d'essais constructeur

N/A

Model / Type Ref.
Ref. de type

602040

Additional information (if necessary may also be reported on page 2)
Les informations complémentaires (si nécessaire, peuvent être indiqués sur la 2^{ème} page)

A sample of the product was tested and found to be in conformity with
Un échantillon de ce produit a été essayé et a été considéré conforme à la

IEC 62133:2012
See Test Report for National Differences

As shown in the Test Report Ref. No. which forms part of this Certificate
Comme indiqué dans le Rapport d'essais numéro de référence qui constitue partie de ce Certificat

50110647 001

This CB Test Certificate is issued by the National Certification Body
Ce Certificat d'essai OC est établi par l'Organisme National de Certification



TÜVRheinland®

TÜV Rheinland Japan Ltd.
Global Technology Assessment Center
4-25-2 Kita-Yamata, Tsuzuki-ku
Yokohama 224-0021 Japan
Phone + 81 45 914-3888
Fax + 81 45 914-3354
Mail: info@jpn.tuv.com
Web: www.tuv.com

Date: 28.11.2017

Signature:

Dipl.-Ing. Univ. S. O. Steinke

Date : 28.11.2017
Our ref. : ZJ
Your ref.: 164111935

Type of Equipment : Li-ion Battery
Model Designation : See Certificate
Certificate No. : JPTUV-084482
Report No. : 50110647 001

Thank you very much for your interest in our services.

Please find enclosed your certification documents.

We appreciate your support and would like to offer our assistance in the approval of your future products through our extensive range of technical services.

Please feel free to contact us whatever your requirements may be.

With kind regards,

Certification Body

Dipl.-Ing. Univ. S. O. Steinke



Enclosure

证书的详细资料请登陆www.certipedia.com查阅,或拨打我司客服热线800 999 3668 / 400 883 1300咨询

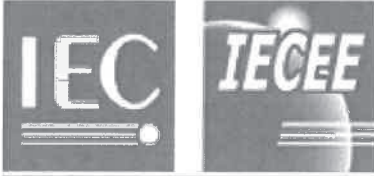

Test Report issued under the responsibility of:



**TEST REPORT
IEC 62133**

Secondary cells and batteries containing alkaline or other non-acid electrolytes – Safety requirements for portable sealed secondary cells, and for batteries made from them, for use in portable applications

Report Number..... : 50110647 001
Date of issue : 2017-11-28
Total number of pages 26 pages

Applicant's name :
Address..... :

Test specification:

Standard : IEC 62133: 2012 (Second Edition)
Test procedure..... : CB Scheme
Non-standard test method : N/A

Test Report Form No. : IEC62133B
Test Report Form(s) Originator : UL(Demko)
Master TRF : Dated 2013-03

Copyright © 2013 Worldwide System for Conformity Testing and Certification of Electrotechnical Equipment and Components (IECEE), Geneva, Switzerland. All rights reserved.

This publication may be reproduced in whole or in part for non-commercial purposes as long as the IECEE is acknowledged as copyright owner and source of the material. IECEE takes no responsibility for and will not assume liability for damages resulting from the reader's interpretation of the reproduced material due to its placement and context.

If this Test Report Form is used by non-IECEE members, the IECEE/IEC logo and the reference to the CB Scheme procedure shall be removed.

This report is not valid as a CB Test Report unless signed by an approved CB Testing Laboratory and appended to a CB Test Certificate issued by an NCB in accordance with IECEE 02.

Test item description..... : Li-ion Battery
Trade Mark..... : N/A
Manufacturer :

Model/Type reference..... : 602040
Ratings..... : 3.7V, 400mAh, 1.48Wh

| | | |
|--|--|--|
| Testing procedure and testing location: | | |
| <input checked="" type="checkbox"/> | CB Testing Laboratory: | TÜV Rheinland (Shenzhen) Co., Ltd. |
| Testing location/ address | | East of F/1, F/2~F/4, Building 1, Cybio Technology Building No. 6 Langshan No.2 Road, North Hi-tech Industry Park 518057 Shenzhen Nanshan District China |
| <input type="checkbox"/> | Associated CB Testing Laboratory: | |
| Testing location/ address | | |
| Tested by (name + signature).....: | | Eric Cui |
| Approved by (name + signature) | | Daniel Dai |
| | | <i>Eric Cui</i> <i>Daniel Dai</i> |
| <input type="checkbox"/> | Testing procedure: TMP | |
| Testing location/ address | | |
| Tested by (name + signature).....: | | |
| Approved by (name + signature) | | |
| <input type="checkbox"/> | Testing procedure: WMT | |
| Testing location/ address | | |
| Tested by (name + signature).....: | | |
| Witnessed by (name + signature) | | |
| Approved by (name + signature) | | |
| <input type="checkbox"/> | Testing procedure: SMT | |
| Testing location/ address | | |
| Tested by (name + signature).....: | | |
| Approved by (name + signature) | | |
| Supervised by (name + signature).....: | | |

| | |
|--|---|
| List of Attachments (including a total number of pages in each attachment): Attachment 1: Photo documentation (5 pages). | |
| Summary of testing: | |
| Tests performed (name of test and test clause): cl.5.6.2 Design recommendation(Lithium system); cl.8.1 Charging procedure for test purposes (for Cells and Pack); cl.8.2.1 Continuous charging at constant voltage (Cells); cl.8.2.2 Moulded case stress at high ambient temperature (battery); cl.8.3.1 External short circuit (Cells); cl.8.3.2 External short circuit (Battery); cl.8.3.3 Free fall (for Cells and Pack); cl.8.3.4 Thermal abuse (Cells); cl.8.3.5 Crush (Cells); cl.8.3.6 Over-charging of battery; cl.8.3.7 Forced discharge (Cells); cl.8.3.8 Transport tests (Cells); cl. 8.3.9 Forced internal short circuit (Cells) | Testing location: TÜV Rheinland (Shenzhen) Co., Ltd. East of F/1, F/2~F/4, Building 1, Cybio Technology Building No. 6 Langshan No.2 Road, North Hi-tech Industry Park 518057 Shenzhen Nanshan District CHINA |
| Tests are made with the number of cells and batteries specified in IEC 62133: 2012 (Second Edition) Table 2. | |
| Summary of compliance with National Differences: BE, BY, CN, DE, DK, FI, FR, GB, HU, JP, KR, NL, NO, SA, SE, SG, SI, US. BE=Belgium, BY=Belarus, CN=China, DE=Germany, DK=Denmark, FI=Finland, FR=France, GB=United Kingdom, HU=Hungary, JP=Japan, KR=Republic of Korea, NL=The Netherlands, NO=Norway, SA= Saudi Arabia, SE=Sweden, SG=Singapore, SI= Slovenia, US= United States of America. | |
| <input checked="" type="checkbox"/> The product fulfils the requirements of <u>EN 62133: 2013</u> | |

Copy of marking plate:

The artwork below may be only a draft. The use of certification marks on a product must be authorized by the respective NCBs that own these marks.

+ (Red) Li-ion Battery

Model: 602040 1INP6/20/41

3.7V 400mAh 1.48Wh

- (Black) Date: 2017.10

Made in China

| | |
|---|---|
| Test item particulars.....: | |
| Classification of installation and use.....: | To be defined in final product |
| Supply connection.....: | DC lead wire |
| Recommend charging method declared by the manufacturer | Charging the battery with 200mA constant current until 4.2V, then constant voltage until the charge current reduces to 8mA at ambient 20°C±5°C. |
| Discharge current (0,2 I_t A) | 80mA |
| Specified final voltage.....: | 3.0V |
| Chemistry | <input type="checkbox"/> nickel systems <input checked="" type="checkbox"/> lithium systems |
| Recommend of charging limit for lithium system | |
| Upper limit charging voltage per cell.....: | 4.25V |
| Maximum charging current | 400mA |
| Charging temperature upper limit | 45°C |
| Charging temperature lower limit.....: | 10°C |
| Polymer cell electrolyte type | <input type="checkbox"/> gel polymer <input type="checkbox"/> solid polymer <input checked="" type="checkbox"/> N/A |
| Possible test case verdicts: | |
| - test case does not apply to the test object.....: | N/A |
| - test object does meet the requirement.....: | P (Pass) |
| - test object does not meet the requirement.....: | F (Fail) |
| Testing.....: | |
| Date of receipt of test item | 2017-10-25 |
| Date (s) of performance of tests.....: | 2017-10-25 to 2017-11-14 |
| General remarks: | |
| The test results presented in this report relate only to the object tested. This report shall not be reproduced, except in full, without the written approval of the Issuing testing laboratory. "(See Enclosure #)" refers to additional information appended to the report. "(See appended table)" refers to a table appended to the report. Throughout this report a <input type="checkbox"/> comma / <input checked="" type="checkbox"/> point is used as the decimal separator. | |
| Manufacturer's Declaration per sub-clause 4.2.5 of IEC 60335-1: | |
| The application for obtaining a CB Test Certificate includes more than one factory location and a declaration from the Manufacturer stating that the sample(s) submitted for evaluation is (are) representative of the products from each factory has been provided : | <input type="checkbox"/> Yes <input checked="" type="checkbox"/> Not applicable |
| When differences exist; they shall be identified in the General product information section. | |
| Name and address of factory (ies) : Same as manufacturer | |

General product information:

This battery is constructed with one lithium-ion cell, and has overcharge, over-discharge, over current and short-circuits proof circuit.

The main features of the cell in the battery pack are shown as below (clause 8.1.1):

| Model | Nominal capacity | Nominal voltage | Nominal Charge Current | Nominal Discharge Current | Maximum Charge Current | Maximum Discharge Current | Maximum Charge Voltage | Cut-off Voltage |
|---------------|------------------|-----------------|------------------------|---------------------------|------------------------|---------------------------|------------------------|-----------------|
| 602040 (cell) | 400mAh | 3.7V | 200mA | 200mA | 400mA | 400mA | 4.2V | 3.0V |

The main features of the cell in the battery pack are shown as below (clause 8.1.2):

| Model | Upper limit charge voltage | Taper-off current | Lower charge temperature | Upper charge temperature |
|---------------|----------------------------|-------------------|--------------------------|--------------------------|
| 602040 (cell) | 4.25V | 20mA | 10°C | 45°C |

The main features of the battery pack are shown as below (clause 8.1.1):

| Model | Nominal capacity | Nominal voltage | Nominal Charge Current | Nominal Discharge Current | Maximum Charge Current | Maximum Discharge Current | Maximum Charge Voltage | Cut-off Voltage |
|--------|------------------|-----------------|------------------------|---------------------------|------------------------|---------------------------|------------------------|-----------------|
| 602040 | 400mAh | 3.7V | 200mA | 200mA | 400mA | 400mA | 4.2V | 3.0V |

The main features of the battery pack are shown as below (clause 8.1.2):

| Model | Upper limit charge voltage | Taper-off current | Lower charge temperature | Upper charge temperature |
|--------|----------------------------|-------------------|--------------------------|--------------------------|
| 602040 | 4.25V | 20mA | 10°C | 45°C |

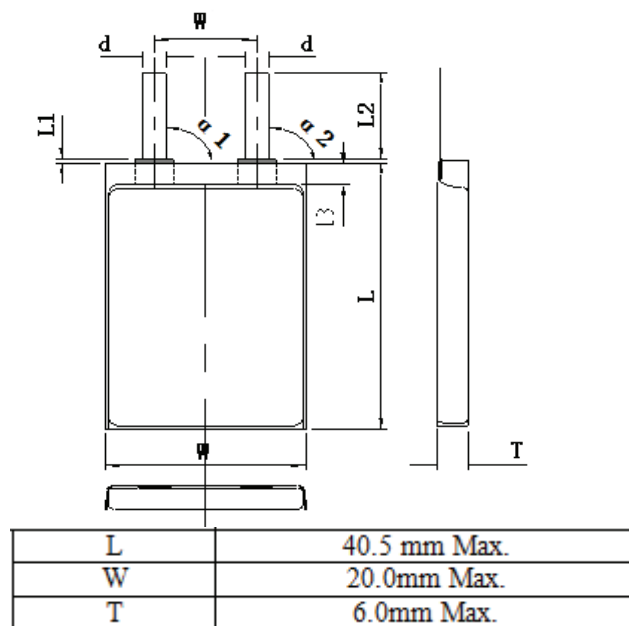
Construction:

Cell

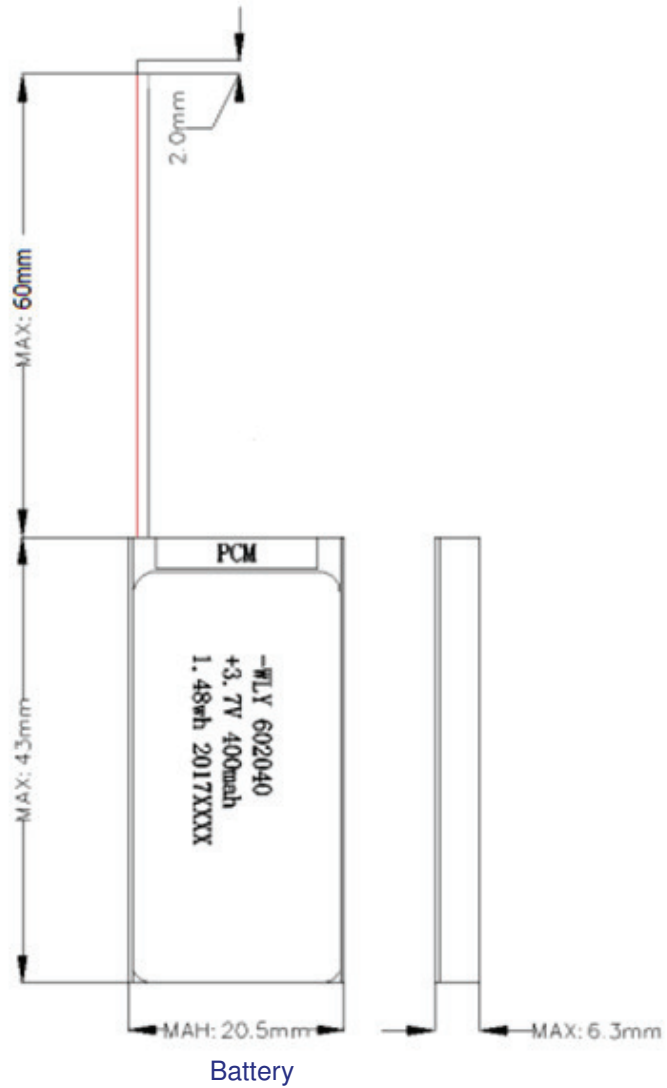

Circuit diagram:

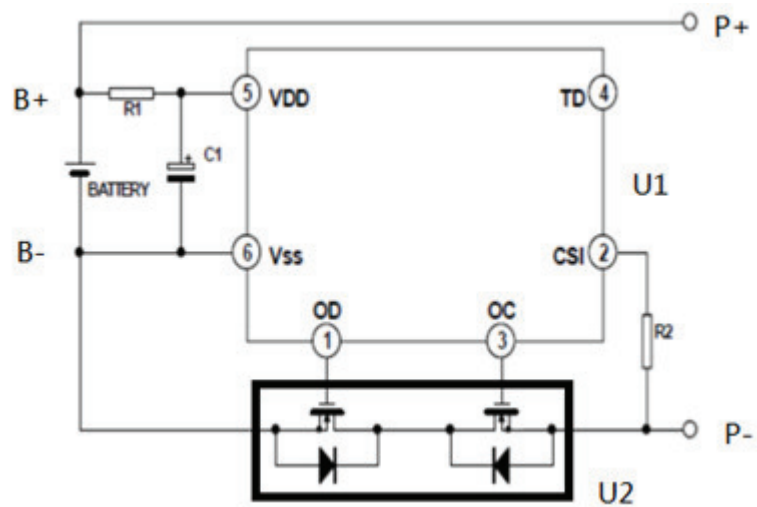

| IEC 62133: 2012 | | | |
|-----------------|---|--|----------|
| Clause | Requirement + Test | Result - Remark | Verdict |
| 4 | Parameter measurement tolerances | | P |
| | Parameter measurement tolerances | | P |
| 5 | General safety considerations | | P |
| 5.1 | General | | P |
| 5.2 | Insulation and wiring | | P |
| | The insulation resistance between the positive terminal and externally exposed metal surfaces of the battery (excluding electrical contact surfaces) is not less than 5 MΩ | No metal case exists. | N/A |
| | Insulation resistance (MΩ)..... : | | — |
| | Internal wiring and insulation are sufficient to withstand maximum anticipated current, voltage and temperature requirements | | P |
| | Orientation of wiring maintains adequate creepage and clearance distances between conductors | | P |
| | Mechanical integrity of internal connections accommodates reasonably foreseeable misuse | | P |
| 5.3 | Venting | | P |
| | Battery cases and cells incorporate a pressure relief mechanism or are constructed so that they relieve excessive internal pressure at a value and rate that will preclude rupture, explosion and self-ignition | Venting mechanism exists on narrow side of the pouch cell. | P |
| | Encapsulation used to support cells within an outer casing does not cause the battery to overheat during normal operation nor inhibit pressure relief | | N/A |
| 5.4 | Temperature/voltage/current management | | P |
| | Batteries are designed such that abnormal temperature rise conditions are prevented | Overcharge, overdischarge, over current and short-circuit proof circuit used in this battery. See tests of clause 8. | P |
| | Batteries are designed to be within temperature, voltage and current limits specified by the cell manufacturer | See above. | P |
| | Batteries are provided with specifications and charging instructions for equipment manufacturers so that associated chargers are designed to maintain charging within the temperature, voltage and current limits specified | The charging limits specified in the manufacturer's specifications. | P |
| 5.5 | Terminal contacts | | P |
| | Terminals have a clear polarity marking on the external surface of the battery | The "+ (Red)" and "- (Black)" polarity explicitly marked on surface of the battery. | P |

| IEC 62133: 2012 | | | |
|-----------------|--|---|---------|
| Clause | Requirement + Test | Result - Remark | Verdict |
| | The size and shape of the terminal contacts ensure that they can carry the maximum anticipated current | DC lead wire contacts complied with the requirements. | P |
| | External terminal contact surfaces are formed from conductive materials with good mechanical strength and corrosion resistance | Complied. | P |
| | Terminal contacts are arranged to minimize the risk of short circuits | Complied. | P |
| 5.6 | Assembly of cells into batteries | | P |
| 5.6.1 | If there is more than one battery housed in a single battery case, cells used in the assembly of each battery have closely matched capacities, be of the same design, be of the same chemistry and be from the same manufacturer | Single cell in the battery. | N/A |
| | Each battery has an independent control and protection | | N/A |
| | Manufacturers of cells make recommendations about current, voltage and temperature limits so that the battery manufacturer/designer may ensure proper design and assembly | | N/A |
| | Batteries that are designed for the selective discharge of a portion of their series connected cells incorporate separate circuitry to prevent the cell reversal caused by uneven discharges | | N/A |
| | Protective circuit components are added as appropriate and consideration given to the end-device application | | N/A |
| | When testing a battery, the manufacturer of the battery provides a test report confirming the compliance according to this standard | | N/A |
| 5.6.2 | Design recommendation for lithium systems only | | P |
| | For the battery consisting of a single cell or a single cellblock: - Charging voltage of the cell does not exceed the upper limit of the charging voltage specified in Clause 8.1.2, Table 4; or | Max. charging voltage: 4.2V, not exceed 4.25V specified in Clause 8.1.2, Table 4. | P |
| | - Charging voltage of the cell does not exceed the different upper limit of the charging voltage determined through Clause 8.1.2, NOTE 1. | | N/A |
| | For the battery consisting of series-connected plural single cells or series-connected plural cellblocks: - The voltages of any one of the single cells or single cellblocks does not exceed the upper limit of the charging voltage, specified in Clause 8.1.2, Table 4, by monitoring the voltage of every single cell or the single cellblocks; or | | N/A |

| IEC 62133: 2012 | | | |
|------------------------|--|---|------------|
| Clause | Requirement + Test | Result - Remark | Verdict |
| | - The voltages of any one of the single cells or single cellblocks does not exceed the different upper limit of the charging voltage, determined through Clause 8.1.2, NOTE 1, by monitoring the voltage of every single cell or the single cellblocks | | N/A |
| | For the battery consisting of series-connected plural single cells or series-connected plural cellblocks: - Charging is stopped when the upper limit of the charging voltage, specified in Clause 8.1.2, Table 4, is exceeded for any one of the single cells or single cellblocks by measuring the voltage of every single cell or the single cellblocks; or | | N/A |
| | - Charging is stopped when the upper limit of the different charging voltage, determined through Clause 8.1.2, NOTE 1, is exceeded for any one of the single cells or single cellblocks by measuring the voltage of every single cell or the single cellblocks | | N/A |
| 5.7 | Quality plan | | P |
| | The manufacturer prepares and implements a quality plan that defines procedures for the inspection of materials, components, cells and batteries and which covers the whole process of producing each type of cell or battery | Complied. ISO 9001: 2015 certificate provided. | P |
| 6 | Type test conditions | | P |
| | Tests were made with the number of cells or batteries specified in Table 1 for nickel-cadmium and nickel-metal hydride systems and Table 2 for lithium systems, using cells or batteries that are not more than six months old | Complied. Lithium system. | P |
| | Unless noted otherwise in the test methods, testing was conducted in an ambient of 20°C ± 5°C. | Tests are carried out at 20°C ± 5°C. | P |
| 7 | Specific requirements and tests (nickel systems) | | N/A |
| 7.1 | Charging procedure for test purposes | Lithium system. | N/A |
| 7.2 | Intended use | | N/A |
| 7.2.1 | Continuous low-rate charging (cells) | | N/A |
| | Results: No fire. No explosion | | N/A |
| 7.2.2 | Vibration | | N/A |
| | Results: No fire. No explosion. No leakage | (See Table 7.2.2) | N/A |
| 7.2.3 | Moulded case stress at high ambient temperature | | N/A |
| | Oven temperature (°C) | | — |
| | Results: No physical distortion of the battery casing resulting in exposure if internal components | | N/A |
| 7.2.4 | Temperature cycling | | N/A |

| IEC 62133: 2012 | | | |
|-----------------|--|-------------------|---------|
| Clause | Requirement + Test | Result - Remark | Verdict |
| | Results: No fire. No explosion. No leakage. | | N/A |
| 7.3 | Reasonably foreseeable misuse | | N/A |
| 7.3.1 | Incorrect installation cell | | N/A |
| | The test was carried out using: - Four fully charged cells of the same brand, type, size and age connected in series, with one of them reversed; or | | N/A |
| | - A stabilized dc power supply. | | N/A |
| | Results: No fire. No explosion | (See Table 7.3.1) | N/A |
| 7.3.2 | External short circuit | | N/A |
| | The cells or batteries were tested until one of the following occurred: - 24 hours elapsed; or | | N/A |
| | - The case temperature declined by 20% of the maximum temperature rise | | N/A |
| | Results: No fire. No explosion | (See Table 7.3.2) | N/A |
| 7.3.3 | Free fall | | N/A |
| | Results: No fire. No explosion. | | N/A |
| 7.3.4 | Mechanical shock (crash hazard) | | N/A |
| | Results: No fire. No explosion. No leakage. | | N/A |
| 7.3.5 | Thermal abuse | | N/A |
| | Oven temperature (°C) | | — |
| | Results: No fire. No explosion. | | N/A |
| 7.3.6 | Crushing of cells | | N/A |
| | The crushing force was released upon: - The maximum force of 13 kN ± 1 kN has been applied; or | | N/A |
| | - An abrupt voltage drop of one-third of the original voltage has been obtained | | N/A |
| | The cell is prismatic type and a second set of samples was tested, rotated 90° around longitudinal axis compared to the first set | | N/A |
| | Results: No fire. No explosion | (See Table 7.3.6) | N/A |
| 7.3.7 | Low pressure | | N/A |
| | Chamber pressure (kPa) | | — |
| | Results: No fire. No explosion. No leakage. | | N/A |
| 7.3.8 | Overcharge | | N/A |
| | Results: No fire. No explosion | (See Table 7.3.8) | N/A |
| 7.3.9 | Forced discharge | | N/A |

| IEC 62133: 2012 | | | |
|------------------------|---|--|----------|
| Clause | Requirement + Test | Result - Remark | Verdict |
| | Results: No fire. No explosion | (See Table 7.3.9) | N/A |
| 8 | Specific requirements and tests (lithium systems) | | P |
| 8.1 | Charging procedures for test purposes | Complied. | P |
| 8.1.1 | First procedure: This charging procedure applied to tests other than those specified in 8.1.2 | | P |
| 8.1.2 | Second procedure: This charging procedure applied to the tests of 8.3.1, 8.3.2, 8.3.4, 8.3.5, and 8.3.9 | | P |
| | If a cell's specified upper and/or lower charging temperature exceeds values for the upper and/or lower limit test temperatures of Table 4, the cells were charged at the specified values plus 5 °C for the upper limit and minus 5 °C for the lower limit | Charge temperature 10-45°C declared. 10°C used for lower limit tests. 45°C used for upper limit tests. | N/A |
| | A valid rationale was provided to ensure the safety of the cell (see Figure A.1) | | N/A |
| | For a different upper limit charging voltage (i.e. other than for lithium cobalt oxide systems at 4,25 V), the applied upper limit charging voltage and upper limit charging temperatures were adjusted accordingly | Lithium cobalt oxide system only. | N/A |
| | A valid rationale was provided to ensure the safety of the cell (see Figure A.1) | 4.25V applied. | N/A |
| 8.2 | Intended use | | P |
| 8.2.1 | Continuous charging at constant voltage (cells) | Tested complied. | P |
| | Results: No fire. No explosion | (See Table 8.2.1) | P |
| 8.2.2 | Moulded case stress at high ambient temperature (battery) | | P |
| | Oven temperature (°C) | 70°C, 7hours | — |
| | Results: No physical distortion of the battery casing resulting in exposure of internal components | No physical distortion of the battery casing. | P |
| 8.3 | Reasonably foreseeable misuse | | P |
| 8.3.1 | External short circuit (cell) | Tested complied. | P |
| | The cells were tested until one of the following occurred: - 24 hours elapsed; or | | N/A |
| | - The case temperature declined by 20% of the maximum temperature rise | | P |
| | Results: No fire. No explosion | (See Table 8.3.1) | P |
| 8.3.2 | External short circuit (battery) | Tested complied. | P |

| IEC 62133: 2012 | | | |
|------------------------|--|------------------------|---------|
| Clause | Requirement + Test | Result - Remark | Verdict |
| | The batteries were tested until one of the following occurred: - 24 hours elapsed; or | | P |
| | - The case temperature declined by 20% of the maximum temperature rise | | N/A |
| | In case of rapid decline in short circuit current, the battery pack remained on test for an additional one hour after the current reached a low end steady state condition | | P |
| | Results: No fire. No explosion | (See Table 8.3.2) | P |
| 8.3.3 | Free fall | Tested complied. | P |
| | Results: No fire. No explosion. | No fire. No explosion. | P |
| 8.3.4 | Thermal abuse (cells) | | P |
| | The cells were held at 130°C ± 2°C for: - 10 minutes; or | Tested complied. | P |
| | - 30 minutes for large cells (gross mass of more than 500 g as defined in IEC 62281) | | N/A |
| | Oven temperature (°C) | 130°C | — |
| | Gross mass of cell (g) | <500g, small cell. | — |
| | Results: No fire. No explosion. | No fire. No explosion. | P |
| 8.3.5 | Crush (cells) | | P |
| | The crushing force was released upon: - The maximum force of 13 kN ± 1 kN has been applied; or | Tested complied. | P |
| | - An abrupt voltage drop of one-third of the original voltage has been obtained; or | | N/A |
| | - 10% of deformation has occurred compared to the initial dimension | | N/A |
| | Results: No fire. No explosion | (See Table 8.3.5) | P |
| 8.3.6 | Over-charging of battery | Tested complied. | P |
| | Test was continued until the temperature of the outer casing: - Reached steady state conditions (less than 10°C change in 30-minute period); or | | N/A |
| | - Returned to ambient | | P |
| | Results: No fire. No explosion | (See Table 8.3.6) | P |
| 8.3.7 | Forced discharge (cells) | Tested complied. | P |
| | Results: No fire. No explosion | (See Table 8.3.7) | P |
| 8.3.8 | Transport tests | Tested complied. | P |

| IEC 62133: 2012 | | | |
|------------------------|--|--|----------|
| Clause | Requirement + Test | Result - Remark | Verdict |
| | Manufacturer's documentation provided to show compliance with UN Recommendations on Transport of Dangerous Goods | Tested complied. | P |
| 8.3.9 | Design evaluation – Forced internal short circuit (cells) | Tested complied. | P |
| | The cells complied with national requirement for: | France, Japan, Republic of Korea and Switzerland. | — |
| | The pressing was stopped upon: - A voltage drop of 50 mV has been detected; or | | N/A |
| | - The pressing force of 800 N (cylindrical cells) or 400 N (prismatic cells) has been reached | 400N for prismatic cells. | P |
| | Results: No fire | (See Table 8.3.9) | P |
| 9 | Information for safety | | P |
| | The manufacturer of secondary cells ensures that information is provided about current, voltage and temperature limits of their products. | Information for safety mentioned in manufacturer's specifications. | P |
| | The manufacturer of batteries ensures that equipment manufacturers and, in the case of direct sales, end-users are provided with information to minimize and mitigate hazards. | Information for safety mentioned in manufacturer's specifications. | P |
| | Systems analyses performed by device manufacturers to ensure that a particular battery design prevents hazards from occurring during use of a product | | N/A |
| | As appropriate, information relating to hazard avoidance resulting from a system analysis is provided to the end user.....: | | N/A |
| 10 | Marking | | P |
| 10.1 | Cell marking | | N/A |
| | Cells marked as specified in the applicable cell standards: IEC 61951-1, IEC 61951-2 or IEC 61960. | The final product is battery. | N/A |
| 10.2 | Battery marking | | P |
| | Batteries marked in accordance with the requirements for the cells from which they are assembled. | The battery is marked in accordance with IEC 61960, also see page 4. | P |
| | Batteries marked with an appropriate caution statement. | | N/A |
| 10.3 | Other information | | P |
| | Storage and disposal instructions marked on or supplied with the battery. | Information for storage instructions mentioned in manufacturer's specifications. | P |

| IEC 62133: 2012 | | | |
|-----------------|--|---|----------|
| Clause | Requirement + Test | Result - Remark | Verdict |
| | Recommended charging instructions marked on or supplied with the battery. | Information for recommended charging instructions mentioned in manufacturer's specifications. | P |
| 11 | Packaging | | P |
| | The materials and packaging design are chosen so as to prevent the development of unintentional electrical conduction, corrosion of the terminals and ingress of environmental contaminants. | | P |
| Annex A | Charging range of secondary lithium ion cells for safe use | | P |
| A.1 | General | | P |
| A.2 | Safety of lithium-ion secondary battery | Complied. | P |
| A.3 | Consideration on charging voltage | Complied. | P |
| A.3.1 | General | | P |
| A.3.2 | Upper limit charging voltage | 4.25V applied. | P |
| A.3.2.1 | General | | P |
| A.3.2.2 | Explanation of safety viewpoint | | N/A |
| A.3.2.3 | Safety requirements, when different upper limit charging voltage is applied | 4.25V applied. | N/A |
| A.4 | Consideration of temperature and charging current | | P |
| A.4.1 | General | | P |
| A.4.2 | Recommended temperature range | See A.4.2.2. | P |
| A.4.2.1 | General | | P |
| A.4.2.2 | Safety consideration when a different recommended temperature range is applied | Charging temperature range declared by client is: 10-45°C | N/A |
| A.4.3 | High temperature range | Not higher than the temperature specific in this standard. | N/A |
| A.4.3.1 | General | | N/A |
| A.4.3.2 | Explanation of safety viewpoint | | N/A |
| A.4.3.3 | Safety considerations when specifying charging conditions in high temperature range | | N/A |
| A.4.3.4 | Safety consideration when specifying new upper limit in high temperature range | | N/A |
| A.4.4 | Low temperature range | Not lower than the temperature specific in this standard. | N/A |
| A.4.4.1 | General | | N/A |
| A.4.4.2 | Explanation of safety viewpoint | | N/A |

| IEC 62133: 2012 | | | |
|------------------------|---|-----------------|---------|
| Clause | Requirement + Test | Result - Remark | Verdict |
| A.4.4.3 | Safety considerations, when specifying charging conditions in low temperature range | | N/A |
| A.4.4.4 | Safety considerations when specifying a new lower limit in the low temperature range | | N/A |
| A.4.5 | Scope of the application of charging current | | P |
| A.5 | Sample preparation | | P |
| A.5.1 | General | | P |
| A.5.2 | Insertion procedure for nickel particle to generate internal short | | P |
| | The insertion procedure carried out at 20°C±5°C and under -25 °C of dew point | | P |
| A.5.3 | Disassembly of charged cell | | P |
| A.5.4 | Shape of nickel particle | | P |
| A.5.5 | Insertion of nickel particle to cylindrical cell | | N/A |
| A.5.5.1 | Insertion of nickel particle to winding core | | N/A |
| A.5.5.2 | Mark the position of nickel particle on the both end of winding core of the separator | | N/A |
| A.5.6 | Insertion of nickel particle to prismatic cell | | P |

| TABLE: Critical components information | | | | | | P |
|---|--|-----------------|--|--------------------|--|---|
| Object/part no. | Manufacturer/ trademark | Type/model | Technical data | Standard | Mark(s) of conformity ¹⁾ | |
| Cell | | 602040 (cell) | 3.7V, 400mAh | IEC 62133: 2012 | Tested with appliance | |
| -Positive electrode | Jiang Xizhi Lithium Technology Co., LTD | ZL-115 | Li(Ni _x Co _y Mn _{1-x-y})O ₂ , (x: 0.5, y: 0.3), PVDF | -- | -- | |
| -Negative electrode | Zhuhai Lianzhong New Materials Co., LTD | LZ-25 | C (Graphite powder), CMC, SBR, SP | -- | -- | |
| -Electrolyte | Hubei Nuobang Electronics Co., Ltd. | NP605-5B | LiPF ₆ +EMC+EC+ DWC | -- | -- | |
| -Separator | Foshan Jinhui Hi- Tech Optoelectronic Material Co., LTD | 0.02*36 | PE, Shutdown temperature: 130°C | -- | -- | |
| PCB | SHENZHEN SAYEA CIRCUIT TECHNOLOGY CO LTD | SY-D | V-0, 130°C | UL 796 | UL E476823 | |
| Protection IC (U1) | Shandong Hanture Technology Co., LTD. | ZLDW01A | V _{CU} : 4.30±0.05V V _{DL} : 2.40±0.1V | -- | Tested with appliance | |
| MOSFET (U2) | Shandong Hanture Technology Co., LTD. | ZL8205A | V _{DS} : 20V, V _{GS} : ±12V, I _D : 6A (TA=25°C) | -- | Tested with appliance | |
| Lead wire (Black & Red) | | 1007 | 26AWG, 80°C, 30V | UL 758 | UL E249743 | |
| Lead wire (Alternative) | Interchangeable | Interchangeable | 26 AWG, 80°C, 30V | UL 758 | UL approved | |
| Tape | JINGJIANG YAHUA PRESSURE SENSITIVE GLUE CO LTD | CT*(c)(g) | 130°C | UL 510 | UL E165111 | |
| Tape (Alternative) | Interchangeable | Interchangeable | 130°C | UL510 | UL approved | |
| Supplementary information: | | | | | | |
| ¹⁾ Provided evidence ensures the agreed level of compliance. | | | | | | |

| 7.2.1 | TABLE: Continuous low rate charge (cells) | | | | | N/A |
|---|---|--|--|-----------------------------|---------|-----|
| Model | Recommended charging method, (CC, CV, or CC/CV) | Recommended charging voltage V_c , (Vdc) | Recommended charging current I_{rec} , (A) | OCV at start of test, (Vdc) | Results | |
| | | | | | | |
| | | | | | | |
| | | | | | | |
| | | | | | | |
| | | | | | | |
| Supplementary information: - No fire or explosion - No leakage - Leakage - Fire - Explosion - Bulge - Others (please explain) | | | | | | |

| 7.2.2 | TABLE: Vibration | | N/A |
|---|-----------------------------|---------|-----|
| Model | OCV at start of test, (Vdc) | Results | |
| | | | |
| | | | |
| | | | |
| | | | |
| | | | |
| Supplementary information: - No fire or explosion - No leakage - Leakage - Fire - Explosion - Bulge - Others (please explain) | | | |

| 7.3.1 | TABLE: Incorrect installation (cells) | | N/A |
|-------|---------------------------------------|---------|-----|
| Model | OCV of reversed cell, (Vdc) | Results | |
| | | | |
| | | | |
| | | | |
| | | | |
| | | | |

Supplementary information:

- No fire or explosion
- No leakage
- Leakage
- Fire
- Explosion
- Bulge
- Others (please explain)

| 7.3.2 | TABLE: External short circuit | | | | | N/A |
|-------|---|--------------------------------|-------------------------------|--|---------|-----|
| Model | Ambient (at 20°C ± 5°C or 55°C ± 5°C) | OCV at start of test, (Vdc) | Resistance of circuit, (Ω) | Maximum case temperature rise ΔT, (°C) | Results | |
| | | | | | | |
| | | | | | | |
| | | | | | | |
| | | | | | | |
| | | | | | | |
| | | | | | | |
| | | | | | | |
| | | | | | | |
| | | | | | | |
| | | | | | | |

Supplementary information:

- No fire or explosion
- No leakage
- Leakage
- Fire
- Explosion
- Bulge
- Others (please explain)

| 7.3.6 | TABLE: Crush | | | N/A |
|-------|--------------------------------|--|---------|-----|
| Model | OCV at start of test, (Vdc) | OCV at removal of crushing force, (Vdc) | Results | |
| | | | | |
| | | | | |
| | | | | |
| | | | | |
| | | | | |

Supplementary information:

- No fire or explosion
- No leakage
- Leakage
- Fire
- Explosion
- Bulge
- Others (please explain)

| 7.3.8 | TABLE: Overcharge | | | | N/A |
|-------|------------------------------|-----------------------------|----------------------------|---------|-----|
| Model | OCV prior to charging, (Vdc) | Maximum charge current, (A) | Time for charging, (hours) | Results | |
| | | | | | |
| | | | | | |
| | | | | | |
| | | | | | |
| | | | | | |

Supplementary information:

- No fire or explosion
- No leakage
- Leakage
- Fire
- Explosion
- Bulge
- Others (please explain)

| 7.3.9 | TABLE: Forced discharge (cells) | | | | N/A |
|-------|---|--------------------------------------|-------------------------------------|---------|-----|
| Model | OCV before application of reverse charge, (Vdc) | Measured reverse charge I_t , (mA) | Time for reversed charge, (minutes) | Results | |
| | | | | | |
| | | | | | |
| | | | | | |
| | | | | | |
| | | | | | |

Supplementary information:

- No fire or explosion
- No leakage
- Leakage
- Fire
- Explosion
- Bulge
- Others (please explain)

| 8.2.1 | TABLE: Continuous charging at constant voltage (cells) | | | | P |
|---|--|---|-----------------------------|---------|---|
| Model | Recommended charging voltage V_C , (Vdc) | Recommended charging current I_{rec} , (mA) | OCV at start of test, (Vdc) | Results | |
| C1# | 4.20 | 400 | 4.17 | P | |
| C2# | 4.20 | 400 | 4.19 | P | |
| C3# | 4.20 | 400 | 4.18 | P | |
| C4# | 4.20 | 400 | 4.18 | P | |
| C5# | 4.20 | 400 | 4.19 | P | |
| Supplementary information: | | | | | |
| <ul style="list-style-type: none"> - No fire - No explosion - No leakage | | | | | |

| 8.3.1 | TABLE: External short circuit (cells) | | | | | P |
|---|---------------------------------------|-----------------------------|-----------------------------|---|---------|---|
| Model | Ambient, (°C) | OCV at start of test, (Vdc) | Resistance of circuit, (mΩ) | Maximum case temperature rise ΔT , (°C) | Results | |
| Samples charged at charging temperature upper limit (45°C) | | | | | | |
| C1# | 25.0 | 4.21 | 80 | 108.3 | P | |
| C2# | 25.0 | 4.22 | 82 | 109.2 | P | |
| C3# | 25.0 | 4.21 | 78 | 114.1 | P | |
| C4# | 25.0 | 4.22 | 80 | 118.4 | P | |
| C5# | 25.0 | 4.21 | 81 | 116.7 | P | |
| Samples charged at charging temperature lower limit (10°C) | | | | | | |
| C6# | 25.0 | 4.16 | 80 | 114.0 | P | |
| C7# | 25.0 | 4.17 | 81 | 101.8 | P | |
| C8# | 25.0 | 4.16 | 81 | 106.5 | P | |
| C9# | 25.0 | 4.16 | 79 | 111.7 | P | |
| C10# | 25.0 | 4.17 | 82 | 117.3 | P | |
| Supplementary information: | | | | | | |
| <ul style="list-style-type: none"> - No fire - No explosion | | | | | | |

| 8.3.2 | TABLE: External short circuit (battery) | | | | | P |
|---|---|-----------------------------|-----------------------------|---|---------|---|
| Model | Ambient, (°C) | OCV at start of test, (Vdc) | Resistance of circuit, (mΩ) | Maximum case temperature rise ΔT , (°C) | Results | |
| Samples charged at charging temperature upper limit (45°C) | | | | | | |
| B1# | 55.0 | 4.22 | 80 | 55.3 | P | |
| B2# | 55.0 | 4.21 | 79 | 55.2 | P | |
| B3# | 55.0 | 4.21 | 82 | 55.4 | P | |
| B4# | 55.0 | 4.21 | 81 | 55.2 | P | |
| B5# | 55.0 | 4.22 | 81 | 55.3 | P | |
| Samples charged at charging temperature lower limit (10°C) | | | | | | |
| B6# | 55.0 | 4.17 | 81 | 55.3 | P | |
| B7# | 55.0 | 4.17 | 82 | 55.3 | P | |
| B8# | 55.0 | 4.16 | 81 | 55.3 | P | |
| B9# | 55.0 | 4.17 | 80 | 55.2 | P | |
| B10# | 55.0 | 4.16 | 78 | 55.2 | P | |
| Supplementary information: | | | | | | |
| - No fire | | | | | | |
| - No explosion | | | | | | |

| 8.3.5 | TABLE: Crush | | | | | P |
|---|-----------------------------|---|---|--------------------------------------|---------|---|
| Model | OCV at start of test, (Vdc) | OCV at removal of crushing force, (Vdc) | Width/diameter of cell before crush, (mm) | Required deformation for crush, (mm) | Results | |
| Samples charged at charging temperature upper limit (45°C) | | | | | | |
| C1# | 4.21 | -- | -- | -- | P | |
| C2# | 4.21 | -- | -- | -- | P | |
| C3# | 4.22 | -- | -- | -- | P | |
| C4# | 4.22 | -- | -- | -- | P | |
| C5# | 4.21 | -- | -- | -- | P | |
| Samples charged at charging temperature lower limit (10°C) | | | | | | |
| C6# | 4.16 | -- | -- | -- | P | |
| C7# | 4.16 | -- | -- | -- | P | |
| C8# | 4.17 | -- | -- | -- | P | |
| C9# | 4.16 | -- | -- | -- | P | |
| C10# | 4.17 | -- | -- | -- | P | |

| |
|---|
| <p>Note: A 13kN force applied at the wide side of prismatic cells.</p> <p>Supplementary information: - No fire - No explosion</p> |
|---|

| 8.3.6 | TABLE: Over-charging of battery | | | | P |
|---|--|-----------------------------|--|---------|----------|
| Constant charging current (A).....: | | 0.8 | | — | |
| Supply voltage (Vdc).....: | | 5.0 | | — | |
| Model | OCV before charging, (Vdc) | Resistance of circuit, (mΩ) | Maximum outer casing temperature, (°C) | Results | |
| B1# | 3.33 | 16.1 | 32.3 | P | |
| B2# | 3.31 | 15.4 | 32.0 | P | |
| B3# | 3.32 | 15.2 | 32.5 | P | |
| B4# | 3.31 | 15.7 | 32.5 | P | |
| B5# | 3.32 | 15.4 | 32.4 | P | |
| <p>Supplementary information: - No fire - No explosion</p> | | | | | |

| 8.3.7 | TABLE: Forced discharge (cells) | | | | P |
|---|---|---|-------------------------------------|---------|----------|
| Model | OCV before application of reverse charge, (Vdc) | Measured Reverse charge I _r , (mA) | Time for reversed charge, (minutes) | Results | |
| C1# | 3.32 | 400 | 90 | P | |
| C2# | 3.32 | 400 | 90 | P | |
| C3# | 3.33 | 400 | 90 | P | |
| C4# | 3.31 | 400 | 90 | P | |
| C5# | 3.32 | 400 | 90 | P | |
| <p>Supplementary information: - No fire - No explosion</p> | | | | | |

| 8.3.8 T-5 | | TABLE: External short circuit (cells) | | | | P |
|-----------|---------------|---------------------------------------|-----------------------------|---|---------|---|
| Model | Ambient, (°C) | OCV at start of test, (Vdc) | Resistance of circuit, (mΩ) | Maximum case temperature rise ΔT , (°C) | Results | |
| C1# | 55.0 | 4.18 | 79 | 102.7 | P | |
| C2# | 55.0 | 4.19 | 82 | 101.2 | P | |
| C3# | 55.0 | 4.18 | 80 | 102.0 | P | |
| C4# | 55.0 | 4.18 | 81 | 108.4 | P | |
| C5# | 55.0 | 4.17 | 81 | 110.8 | P | |
| C6# | 55.0 | 4.19 | 81 | 113.6 | P | |
| C7# | 55.0 | 4.18 | 82 | 116.1 | P | |
| C8# | 55.0 | 4.19 | 79 | 110.2 | P | |
| C9# | 55.0 | 4.17 | 80 | 112.0 | P | |
| C10# | 55.0 | 4.18 | 81 | 105.8 | P | |

Supplementary information:
The external short-circuit test of 10 pcs samples performed after the test of Altitude, Thermal cycling, Vibration and Shock in sequence.
- No excessive temperature rise, no rupture, no explosion and no fire.

| 8.3.9 | | TABLE: Forced internal short circuit (cells) | | | | P |
|-------|-----------------------|--|---------------------------------|-------------------------------|--------------------|---------|
| Model | Chamber ambient, (°C) | OCV at start of test, (Vdc) | Particle location ¹⁾ | Maximum applied pressure, (N) | Voltage drop, (mV) | Results |
| C1# | 45 | 4.22 | 1 | 400 | 2 | P |
| C2# | 45 | 4.21 | 1 | 400 | 3 | P |
| C3# | 45 | 4.21 | 1 | 400 | 1 | P |
| C4# | 45 | 4.22 | 2 | 400 | 1 | P |
| C5# | 45 | 4.22 | 2 | 400 | 3 | P |
| C6# | 10 | 4.16 | 1 | 400 | 2 | P |
| C7# | 10 | 4.17 | 1 | 400 | 1 | P |
| C8# | 10 | 4.17 | 1 | 400 | 3 | P |
| C9# | 10 | 4.17 | 2 | 400 | 3 | P |
| C10# | 10 | 4.16 | 2 | 400 | 2 | P |

Supplementary information:
¹⁾ Identify one of the following:
1: Nickel particle inserted between positive and negative (active material) coated area.
2: Nickel particle inserted between positive aluminium foil and negative active material coated area.
- No fire

| National Difference | | | |
|---------------------|--------------------|-----------------|---------|
| Consumer Goods | Requirement + Test | Result - Remark | Verdict |

| ATTACHMENT TO TEST REPORT IEC 62133 (ED 2.0) SINGAPORE NATIONAL DIFFERENCES | |
|--|--|
| Differences according to: | Consumer Protection (Consumer Goods Safety Requirements) Regulations [CGSR] as detailed in Appendix F Additional Safety Requirements Imposed by SPRING Singapore as the Safety Authority |
| Attachment Form No.: | SG_ND_IEC62133B |
| Attachment Originator | TÜV Rheinland (Shenzhen) Co., Ltd. |
| Master Attachment | Date 2015-08 |

| | | | |
|-----------------------------------|---|--|-----|
| Portable power banks ¹ | <p>1. Portable power banks shall comply with the requirements of the following safety standards:</p> <p>1.1 IEC 62133:2012 Secondary cells and batteries containing alkaline or non-acid electrolytes – Safety requirements for portable sealed secondary cells, and for batteries made from them, for use in portable applications; and</p> <p>1.2 IEC 60950-1:2005+A1:2009+A2:2013 Information technology equipment – Safety – Part 1: General requirements</p> <p>OR</p> <p>1.3 Any other industry standard specific to power banks</p> <p>2 Portable power banks shall be supplied with the following safety information:</p> <p>2.1 'Minimum Instructions for use' as specified below</p> <p>2.2 Instructions on how to charge the portable power bank</p> <p>2.3 Information on the minimum and maximum operating temperatures of the portable power bank</p> | | N/A |
|-----------------------------------|---|--|-----|

| National Difference | | | |
|---------------------|--|-----------------|---------|
| Consumer Goods | Requirement + Test | Result - Remark | Verdict |
| | <p>Minimum Instructions² for Use for Portable Power Banks to be provided with portable power banks to the customer</p> <p>a) The power bank will generate heat when charging. Always charge in a well ventilated area. Do not charge under pillows, blankets or on flammable surfaces.</p> <p>b) Keep the power bank away from heat sources, direct sunlight, combustible gas, humidity, water or other liquids.</p> <p>c) Do not disassemble, open, microwave, incinerate, paint or insert foreign objects into the power bank.</p> <p>d) Do not subject the power bank to mechanical shock such as crushing, bending, puncturing or shredding. Avoid dropping or placing heavy object on the power bank.</p> <p>e) Do not short-circuit the power bank or store it in a receptacle where it may be short-circuited by other metallic or conductive objects.</p> <p>f) Do not operate the power bank if it has been wet or otherwise damaged, to prevent against electric shock, explosion and/or injury. Contact the dealer or authorized agent.</p> <p>g) Power bank usage by children should be supervised.</p> <p>h) Please read the operating instructions (including charging instructions and information on the minimum and maximum operating temperatures), supplied with this power bank.</p> | | N/A |

-- End of Report --

Product: Li-ion Battery

Type Designation: 602040

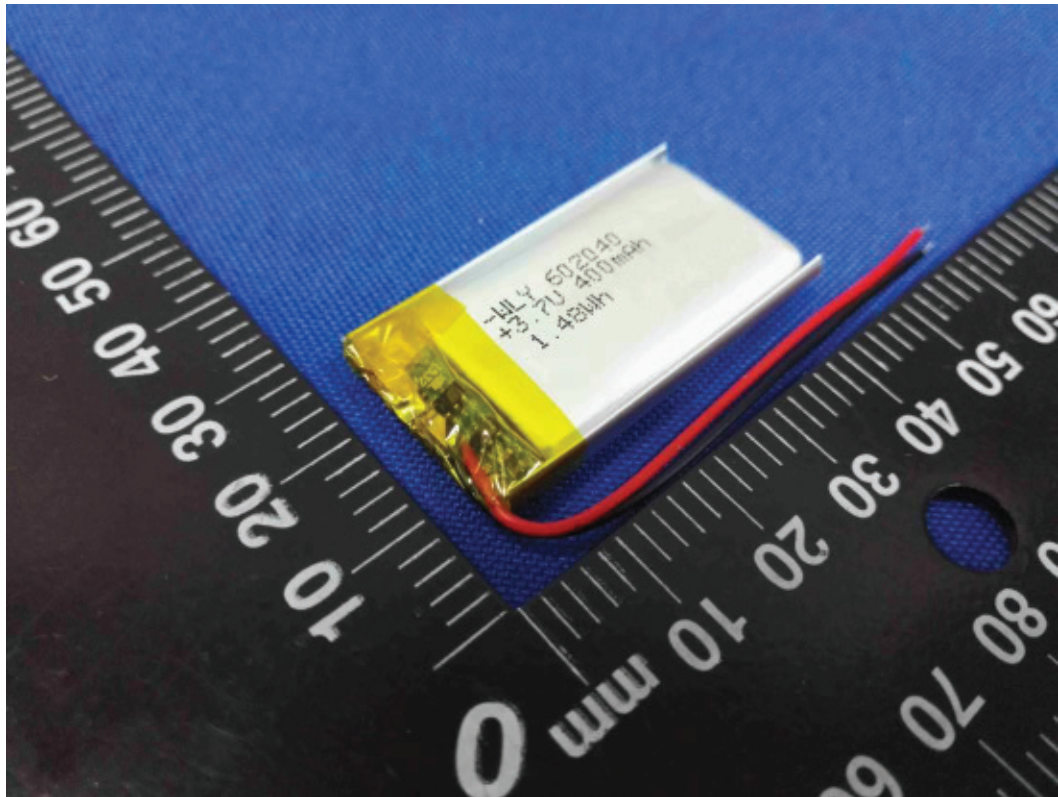

Picture 1. Battery view-1

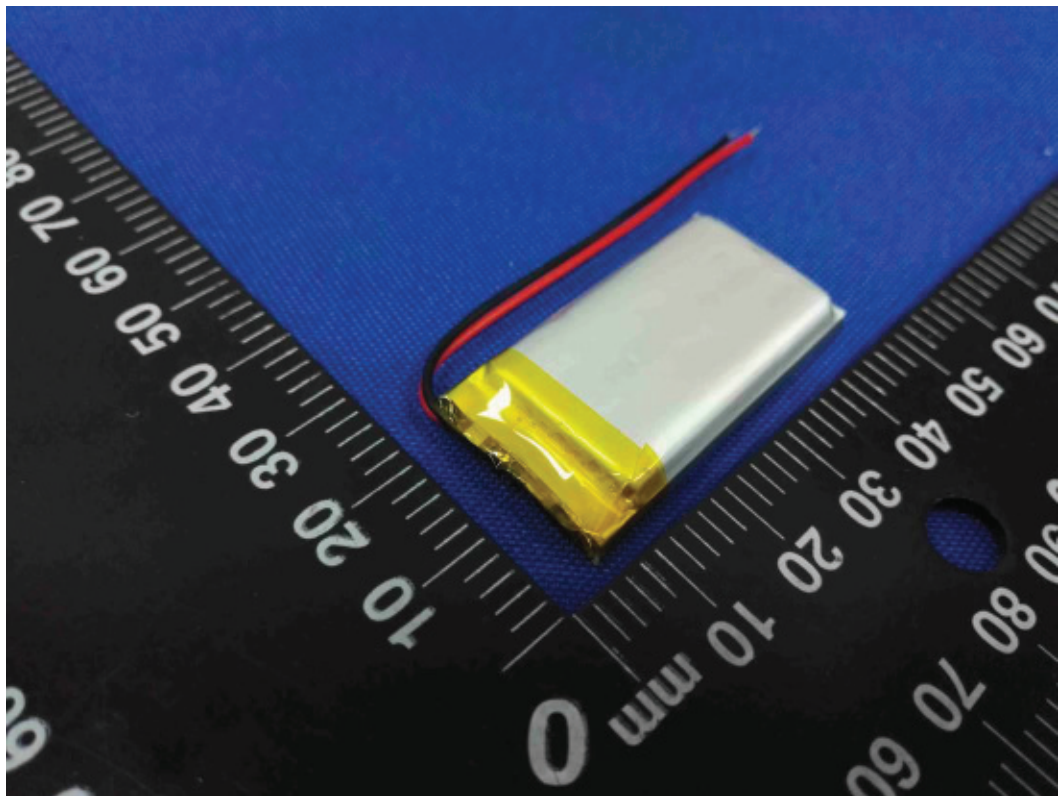

Picture 2. Battery view-2

Product: Li-ion Battery

Type Designation: 602040

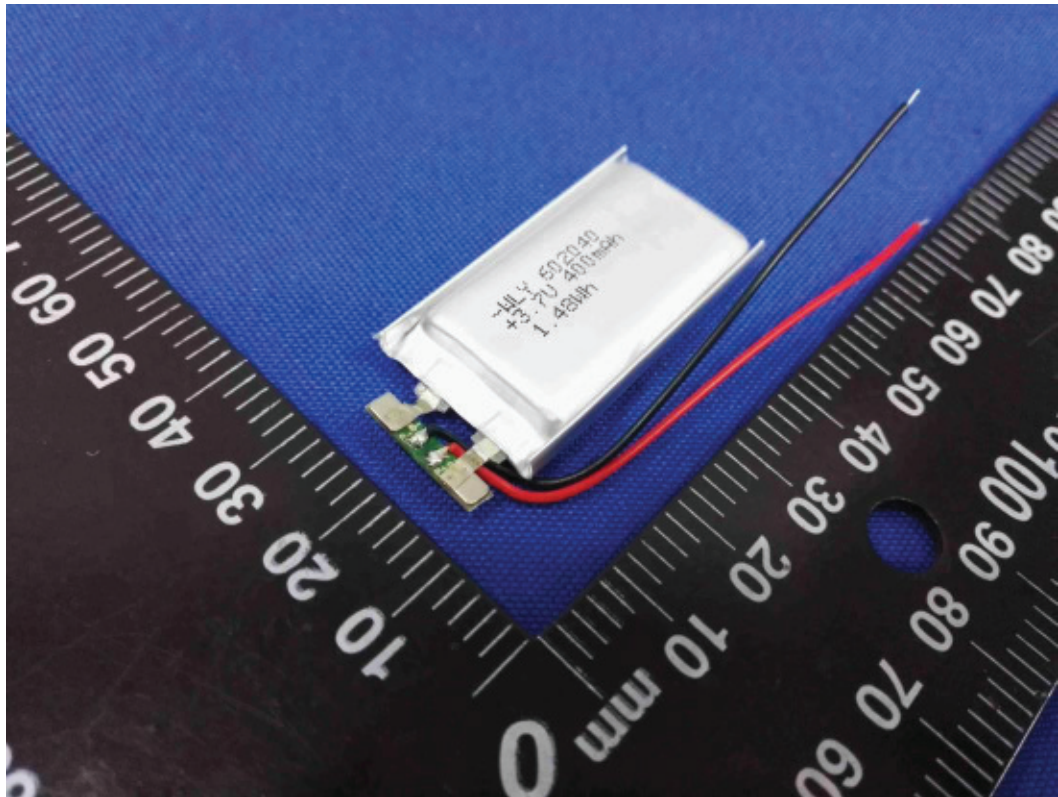

Picture 3. Battery view-3

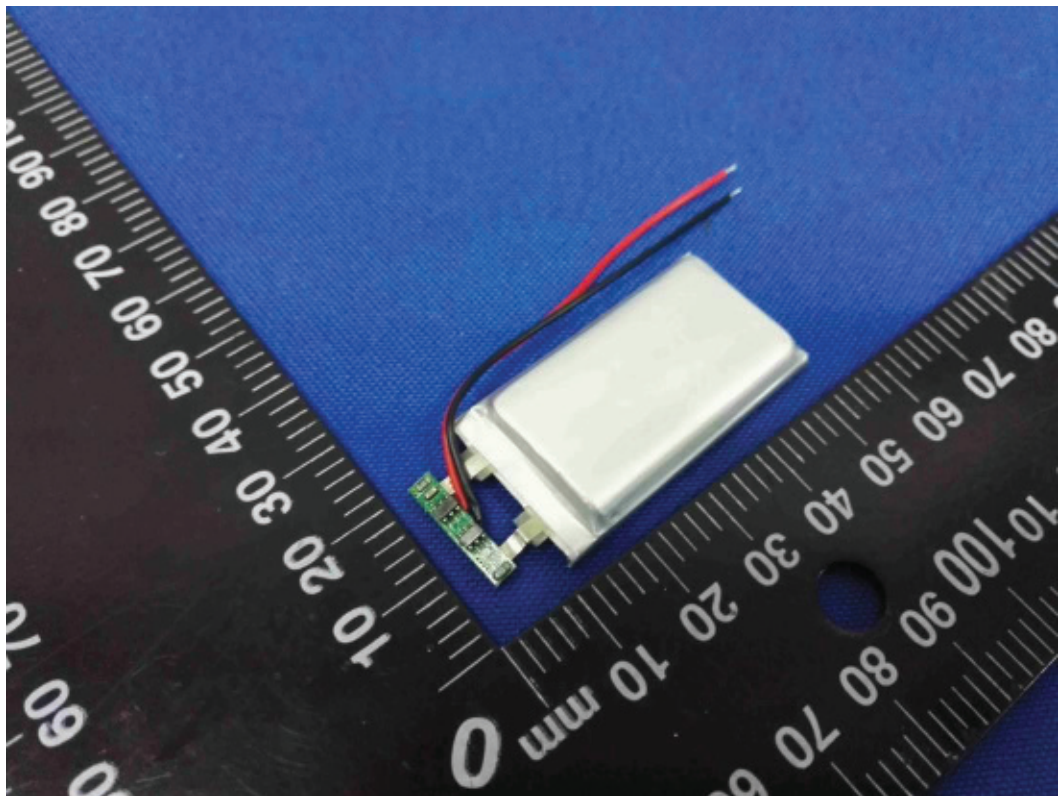

Picture 4. Battery view-4

Product: Li-ion Battery

Type Designation: 602040

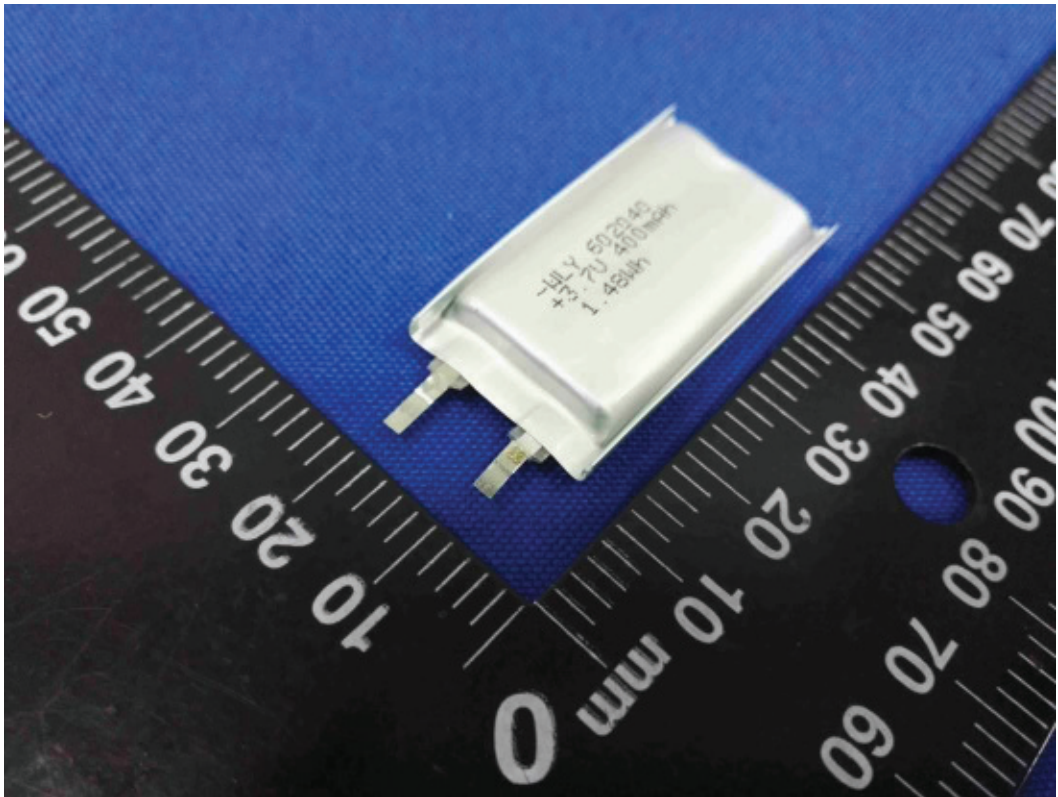

Picture 5. Cell view-1

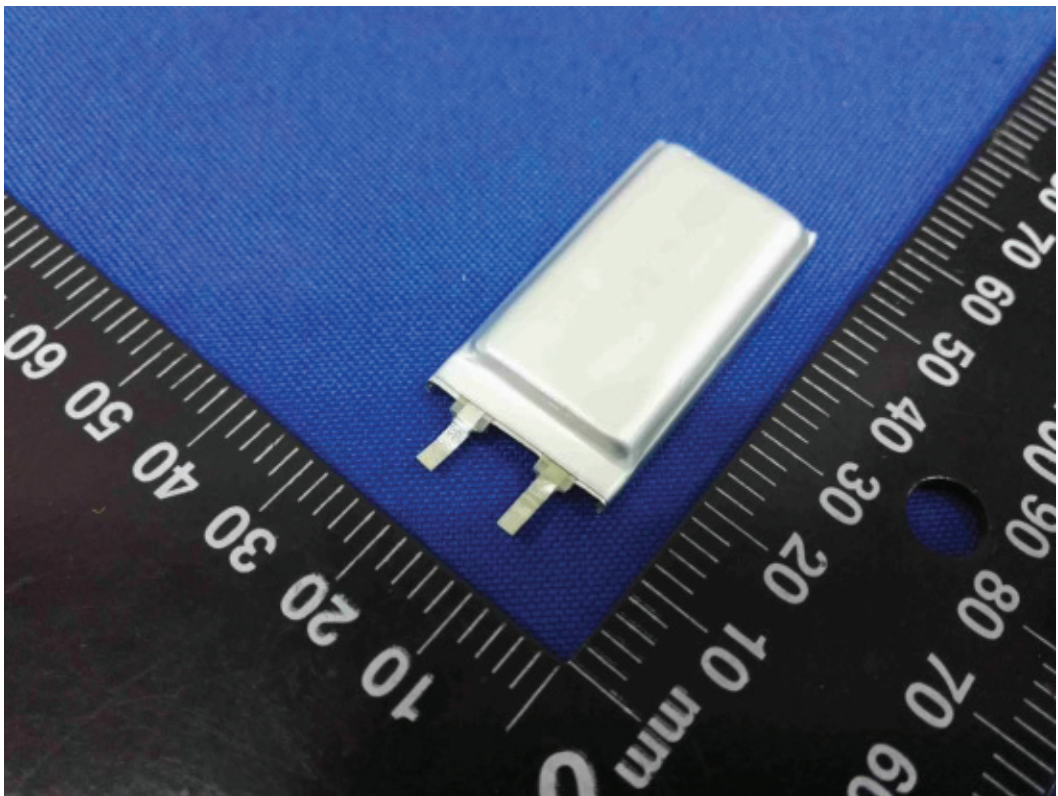

Picture 6. Cell view-2

Product: Li-ion Battery

Type Designation: 602040

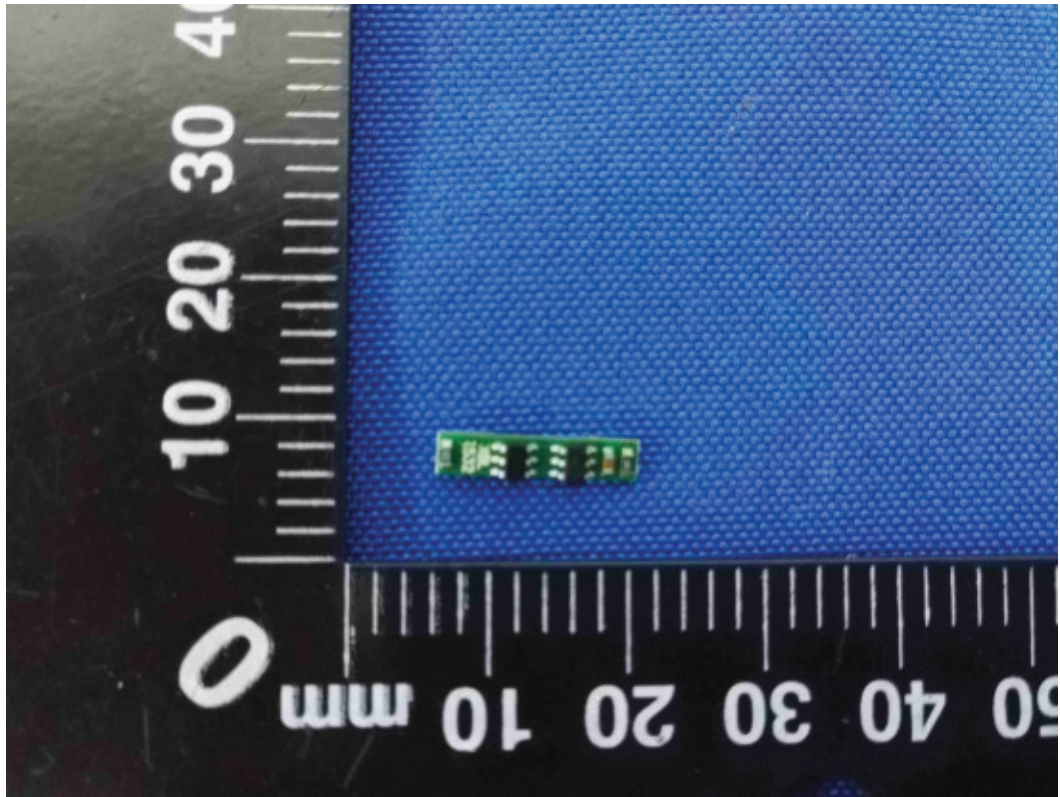

Picture 7. Protection board view-1

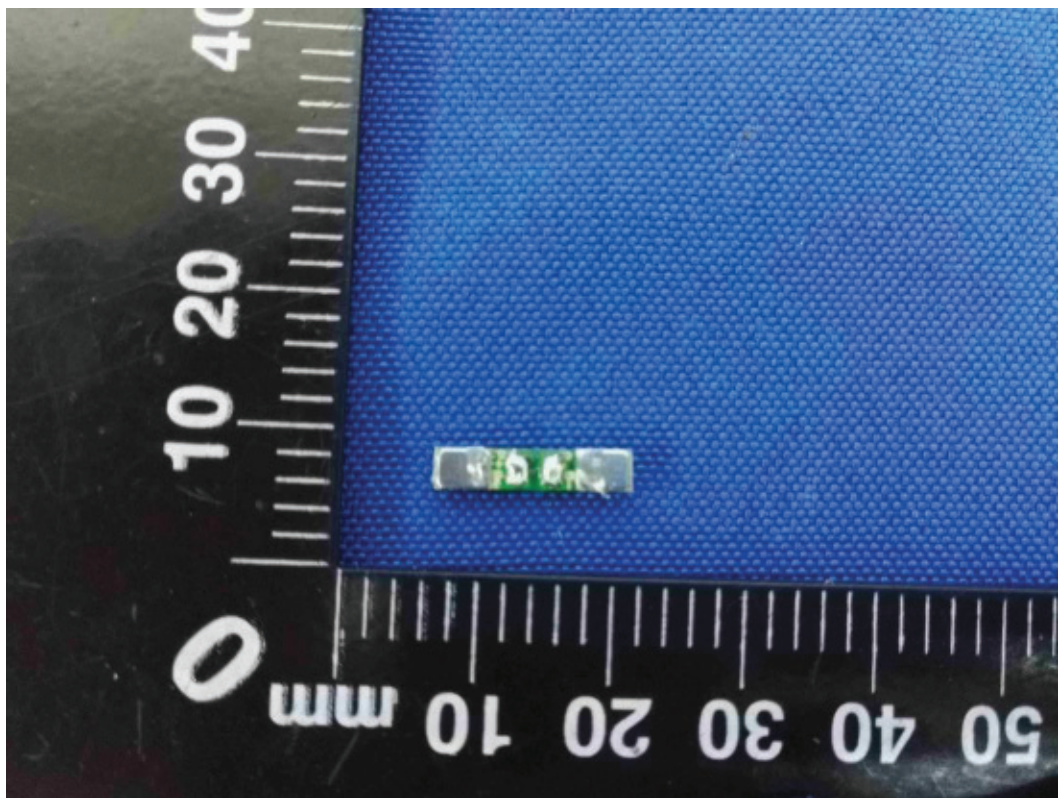

Picture 8. Protection board view-2

Product: Li-ion Battery

Type Designation: 602040

+ (Red) Li-ion Battery

Model: 602040 1INP6/20/41

3.7V 400mAh 1.48Wh

- (Black) Date: 2017.10

Made in China

Picture 9. Label