

# TECHNICAL REPORT



Report No.: EMC 1804006

File reference No.: 2018-04-12

Applicant: Mid Ocean Brands B.V.

Product: Keyring torch with token

Brand Name: N/A

Model No.: MO8466

Test Standards: EN 55015: 2013+A1:2015  
EN 61547: 2009  
EN 61000-3-2: 2014  
EN 61000-3-3:2013

Test result: The EMC testing has been performed on the submitted samples and found in compliance with council EMC Directive 2014/30/EU.

Approved By



Terry Tang  
Manager

Dated: April 12, 2018

**Results appearing herein relate only to the sample tested**

**The technical reports is issued errors and omissions exempt and is subject to withdrawal at**

**SHENZHEN TIMEWAY TESTING LABORATORIES.**

**Room 512-519, 5/F., East Tower, Building 4, Anhua Industrial Zone,  
Futian District, Shenzhen, Guangdong China**

Tel (+86 755)8344 8688 Fax (+86 755)8344 2996 Email: info@timeway-lab.com



### **Special Statement:**

The testing quality ability of our laboratory meet with "Quality Law of People's Republic of China" Clause 19.

The testing quality system of our laboratory meet with ISO/IEC-17025 requirements, which is approved by CNAS. This approval result is accepted by MRA of APLAC.

Our test facility is recognized, certified, or accredited by the following organizations:

#### **CNAS-LAB Code: L2292**

The EMC Laboratory has been assessed and in compliance with CNAS-CL01 accreditation criteria for testing Laboratories (identical to ISO/IEC 17025:2005 General Requirements) for the Competence of testing Laboratories.

#### **FCC-Registration No.: 899988**

The EMC Laboratory has been registered and fully described in a report filed with the (FCC) Federal Communications commission. The acceptance letter from the FCC is maintained in our files. Registration No.: 899988.

#### **IC- Registration No.: IC5205A-02**

The EMC Laboratory has been registered and fully described in a report filed with the (IC) Industry Canada. The acceptance letter from the IC is maintained in our files. Registration IC No.: 5205A-02.

#### **VCCI- Registration No.: R-3015 and C-3332**

The EMC Laboratory has been registered and fully described in a report filed with the (VCCI) Voluntary Control Council for Interference. The acceptance letter from the VCCI is maintained in our files. Registration IC No.: R-3015 and C-3332

The report refers only to the sample tested and does not apply to the bulk.

This report is issued in confidence to the client and it will be strictly treated as such by the SHENZHEN TIMEWAY TESTING LABORATORIES. It may not be reproduced rather in its entirety or in part and it may not be used for adverting. The client to whom the report is issued may, however, show or send it . or a certified copy there of prepared by the SHENZHEN TIMEWAY TESTING LABORATORIES. to his customer. Supplier or others persons directly concerned. SHENZHEN TIMEWAY TESTING LABORATORIES. will not, without the consent of the client enter into any discussion of correspondence with any third party concerning the contents of the report. In the event of the improper use of the report. The SHENZHEN TIMEWAY TESTING LABORATORIES. reserves the rights to withdraw it and to adopt any other remedies which may be appropriate.



## Content

<b>Content</b>	3
<b>1.0 General Details</b>	6
1.1 Test Lab Details	6
1.2 Applicant Details	6
1.3 Description of EUT	6
1.4 Submitted Sample	6
1.5 Test Duration	6
1.6 Test Uncertainty	6
1.7 Test or witness Engineer	6
<b>2.0 List of Measurement Equipment</b>	7
2.1 Conducted Emission Test	7
2.2 Radiated Disturbance Test	7
2.3 Harmonic & Flicker Test	7
2.4 ESD Test	7
2.5 RF field Strength Susceptibility	8
2.6 Electrical Fast Transient/Burst (EFT/B) Immunity test	8
2.7 Surge Test	8
2.8 Conducted Immunity Test	8
2.9 Power-frequency Magnetic Field	8
2.10 Voltage Dips/Interruption Immunity Test	9
<b>3.0 Technical Details</b>	10
3.1 Investigations Requested	10
3.2 Test Standards	10
<b>4.0 Disturbance Voltage Test</b>	11
4.1 Schematics of the test	11
4.2 Test Method:	11
4.3 Disturbance Voltage Limits	11
4.4 Test Results	12
<b>5.0 Radiated electromagnetic disturbances</b>	15
5.1 Schematics of the test	15
5.2 Test Method:	15
5.3 Radiated electromagnetic disturbances Limits	15
5.4 Radiated electromagnetic disturbances in X (9kHz to 30MHz)	16
<b>6.0 Radiated Disturbance Test</b>	19
6.1 Schematics of the test	19
6.2 Test Method:	19
6.3 Power line conducted Emission Limit	19

The report refers only to the sample tested and does not apply to the bulk.

This report is issued in confidence to the client and it will be strictly treated as such by the SHENZHEN TIMEWAY TESTING LABORATORIES. It may not be reproduced rather in its entirety or in part and it may not be used for advertising. The client to whom the report is issued may, however, show or send it, or a certified copy thereof prepared by the SHENZHEN TIMEWAY TESTING LABORATORIES, to his customer, Supplier or others persons directly concerned. SHENZHEN TIMEWAY TESTING LABORATORIES, will not, without the consent of the client enter into any discussion of correspondence with any third party concerning the contents of the report.

In the event of the improper use of the report, The SHENZHEN TIMEWAY TESTING LABORATORIES, reserves the rights to withdraw it and to adopt any other remedies which may be appropriate.



6.4	Test result.....	19
<b>7.0</b>	<b>Voltage Fluctuations &amp; Flicker Test</b> .....	<b>22</b>
7.1	Schematic of the test.....	22
7.2	Test Method:.....	22
7.3	Test Results.....	22
<b>8.0</b>	<b>Harmonic Current Emission Test</b> .....	<b>23</b>
8.1	Schematic of the test.....	23
8.2	Test Method.....	23
8.3	Test Results: N/A.....	23
<b>9.0</b>	<b>Electrostatic Discharge</b> .....	<b>24</b>
9.1	Schematic of the test.....	24
9.2	Test method.....	24
9.3	Test severity.....	24
9.4	Susceptibility performance Criteria and Severity level.....	24
9.5	Test Result.....	25
<b>10.0</b>	<b>RF field strength susceptibility (80MHz----- 1000MHz)</b> .....	<b>26</b>
10.1	Schematics of the test.....	26
10.2	Test Method:.....	26
10.3	Susceptibility performance Criteria and severity Level.....	26
10.4	Test Result:.....	27
<b>11.0</b>	<b>Electrical Fast Transient/Burst (EFT/B) immunity test</b> .....	<b>28</b>
11.1	Schematics of the test.....	28
11.2	Test Method.....	28
11.3	Susceptibility performance Criteria and Severity Level.....	28
11.4	Test Results.....	29
<b>12.0</b>	<b>Surge test</b> .....	<b>30</b>
12.1	Schematics of the test.....	30
12.2	Test Method:.....	30
12.3	Susceptibility performance Criteria and Severity Level.....	30
12.4	Test Results.....	31
<b>13.0</b>	<b>Conducted Immunity test</b> .....	<b>32</b>
13.1	Schematics of the test.....	32
13.2	Test Method.....	32
13.3	Susceptibility performance Criteria and Severity Level.....	32
13.4	Test Results.....	33
<b>14.0</b>	<b>Power Frequency magnetic field test</b> .....	<b>34</b>
14.1	Schematics of the test.....	34
14.2	Test Method.....	34
14.3	Susceptibility performance Criteria and Severity Level.....	34

The report refers only to the sample tested and does not apply to the bulk.  
This report is issued in confidence to the client and it will be strictly treated as such by the SHENZHEN TIMEWAY TESTING LABORATORIES. It may not be reproduced rather in its entirety or in part and it may not be used for advertising. The client to whom the report is issued may, however, show or send it, or a certified copy thereof prepared by the SHENZHEN TIMEWAY TESTING LABORATORIES, to his customer, Supplier or others persons directly concerned. SHENZHEN TIMEWAY TESTING LABORATORIES, will not, without the consent of the client enter into any discussion of correspondence with any third party concerning the contents of the report.  
In the event of the improper use of the report, The SHENZHEN TIMEWAY TESTING LABORATORIES, reserves the rights to withdraw it and to adopt any other remedies which may be appropriate.



14.4	Test Results:.....	35
<b>15.0</b>	<b>Voltage Dips/Interruptions immunity test.....</b>	<b>36</b>
15.1	Schematics of the test .....	36
15.2	Test Method: .....	36
15.3	Susceptibility performance Criteria and Severity Level .....	36
15.4	Test Result: .....	37
<b>16.0</b>	<b>Product Labelling .....</b>	<b>38</b>
16.1	CE Mark label specification .....	38
16.2	Mark Location: Rear enclosure.....	38
	Appendix: .....	39

The report refers only to the sample tested and does not apply to the bulk.

This report is issued in confidence to the client and it will be strictly treated as such by the SHENZHEN TIMEWAY TESTING LABORATORIES. It may not be reproduced rather in its entirety or in part and it may not be used for advertising. The client to whom the report is issued may, however, show or send it . or a certified copy there of prepared by the SHENZHEN TIMEWAY TESTING LABORATORIES. to his customer. Supplier or others persons directly concerned. SHENZHEN TIMEWAY TESTING LABORATORIES. will not, without the consent of the client enter into any discussion of correspondence with any third party concerning the contents of the report.

In the event of the improper use of the report. The SHENZHEN TIMEWAY TESTING LABORATORIES. reserves the rights to withdraw it and to adopt any other remedies which may be appropriate.





## 1.0 General Details

### 1.1 Test Lab Details

Name : SHENZHEN TIMEWAY TESTING LABORATORIES  
Address: Room 512-519,5/F., East Tower,Building 4, Anhua Industrial Zone, Futian District,  
Shenzhen,Guangdong China  
Telephone: (086) 755-83448688  
Fax: (086) 755-83442996

### 1.2 Applicant Details

Applicant: Mid Ocean Brands B.V.  
Address: Unit 201, 2/F, Laford Centre, 838 Lai Chi Kok, Cheung Sha Wan, Kowloon, Hong  
Kong.  
Telephone: 0574-62490228  
Fax: 0574-62490197

### 1.3 Description of EUT

Product: Keyring torch with token  
Manufacturer: Mid Ocean Brands B.V.  
Address: Unit 201, 2/F, Laford Centre, 838 Lai Chi Kok, Cheung Sha Wan, Kowloon, Hong  
Kong.  
Brand Name: N/A  
Model Number: MO8466  
Adding Model Number: N/A  
Rating: --  
The Difference between models:--

### 1.4 Submitted Sample

1 sample

### 1.5 Test Duration

Date of Receipt of Test Item: March 31, 2018  
Date of Test: March 31, 2018 ~ April 12, 2018

### 1.6 Test Uncertainty

Conducted Emissions Uncertainty =3.6dB  
Radiated Emissions Uncertainty =4.7dB

### 1.7 Test or witness Engineer

The sample tested by

  
Print Name: Leo Lau

The report refers only to the sample tested and does not apply to the bulk.  
This report is issued in confidence to the client and it will be strictly treated as such by the SHENZHEN TIMEWAY TESTING LABORATORIES. It may not be reproduced rather in its entirety or in part and it may not be used for adverting. The client to whom the report is issued may, however, show or send it . or a certified copy there of prepared by the SHENZHEN TIMEWAY TESTING LABORATORIES. to his customer. Supplier or others persons directly concerned. SHENZHEN TIMEWAY TESTING LABORATORIES. will not, without the consent of the client enter into any discussion of correspondence with any third party concerning the contents of the report.  
In the event of the improper use of the report. The SHENZHEN TIMEWAY TESTING LABORATORIES. reserves the rights to withdraw it and to adopt any other remedies which may be appropriate.



## 2.0 List of Measurement Equipment

### 2.1 Conducted Emission Test

Name	Model No.	Serial No.	Manufacturer	Calibration Date	Calibration Cycle
EMI Test Receiver	ESH3	860905/006	RS	2017.06.11	1Year
Spectrum Analyzer	ESA-L1500A	US37451154	HP	2017.06.11	1Year
PULSE LIMITER	ESH3-Z2	100281	RS	2017.06.11	1Year
LISN	ESH3-Z5	100294	RS	2017.06.11	1Year
LISN	ESH3-Z5	100253	RS	2017.06.11	1Year

### 2.2 Radiated Disturbance Test

Name	Model No	Serial No.	Manufacturer	Calibration Date	Calibration Cycle
EMI Test Receiver	ESVD	100008	RS	2017.06.11	1Year
Coaxial Switch	MP59B	M70585	ANRITSU	N/A	N/A
Spectrum Analyzer	8595E	3441A00893	HP	2017.06.11	1Year
Amplifier	8447D	2727A05017	HP	2017.06.11	1Year
Bilog Antenna	VULB9163	9163/340	Schwarebeck	2017.06.11	1Year

### 2.3 Harmonic & Flicker Test

Name	Model No.	Serial No.	Manufacturer	Calibration Date	Calibration Cycle
Harmonics Flicker Test System	PACS-1	72305	CI	2017.09.29	1Year
5K VA AC Power Source	5001iX	56060	CI	2017.09.29	N/A

### 2.4 ESD Test

Name	Model No.	Serial No.	Manufacturer	Calibration Date	Calibration Cycle
ESD Simulator	DITO	0404-24	EM TEST	2017.06.08	1Year

The report refers only to the sample tested and does not apply to the bulk.

This report is issued in confidence to the client and it will be strictly treated as such by the SHENZHEN TIMEWAY TESTING LABORATORIES. It may not be reproduced rather in its entirety or in part and it may not be used for advertising. The client to whom the report is issued may, however, show or send it, or a certified copy thereof prepared by the SHENZHEN TIMEWAY TESTING LABORATORIES, to his customer, supplier or other persons directly concerned. SHENZHEN TIMEWAY TESTING LABORATORIES, will not, without the consent of the client enter into any discussion of correspondence with any third party concerning the contents of the report.

In the event of the improper use of the report, the SHENZHEN TIMEWAY TESTING LABORATORIES, reserves the rights to withdraw it and to adopt any other remedies which may be appropriate.



## 2.5 RF field Strength Susceptibility

Name	Model No.	Serial No.	Manufacturer	Calibration Date	Calibration Cycle
Signal Generator	SMT03	100059	RS	2017.06.11	1Year
Power Meter	NRVS	---	RS	2017.06.11	1Year
Voltage Probe	URV5-Z2	100012	RS	2017.06.11	1Year
Voltage Probe	URV5-Z2	100013	RS	2017.06.11	1Year
Power Amplifier	150W1000	300999	AR	2017.06.11	1Year
Power Amplifier	25S1G4AM1	305993	AR	2017.06.11	1Year
Field Probe	CBL6111C	2576	Holiday	2017.06.11	1Year
Bilog Antenna	MCDC	---	Chase	2017.06.11	1Year

## 2.6 Electrical Fast Transient/Burst (EFT/B) Immunity test

Name	Model No.	Serial No.	Manufacturer	Calibration Date	Calibration Cycle
EFT Generator	UCS 500 M4	0304-42	EM TEST	2017.06.11	1Year
Power Source	MV2616	0104-14	EM TEST	2017.06.11	1Year

## 2.7 Surge Test

Name	Model No.	Serial No.	Manufacturer	Calibration Date	Calibration Cycle
Ultra Compact Simulator	UCS 500 M4	0304-42	EM TEST	2017.06.11	1Year
Power Source	MV2616	0104-14	EM TEST	2017.06.11	1Year

## 2.8 Conducted Immunity Test

Name	Model No.	Serial No.	Manufacturer	Calibration Date	Calibration Cycle
Continuous Wave Simulator	CWS 500C	0407-05	EM TEST	2017.06.11	1 Year

## 2.9 Power-frequency Magnetic Field

Name	Model No.	Serial No.	Manufacturer	Calibration Date	Calibration Cycle
Continuous Wave Simulator	UCS 500 M4	0304-42	EM TEST	2017.06.11	1 Year
Power Source Network	MV 2616	0104-14	EM TEST	2017.06.11	1 Year

The report refers only to the sample tested and does not apply to the bulk.

This report is issued in confidence to the client and it will be strictly treated as such by the SHENZHEN TIMEWAY TESTING LABORATORIES. It may not be reproduced rather in its entirety or in part and it may not be used for advertising. The client to whom the report is issued may, however, show or send it, or a certified copy thereof prepared by the SHENZHEN TIMEWAY TESTING LABORATORIES, to his customer. Supplier or others persons directly concerned. SHENZHEN TIMEWAY TESTING LABORATORIES, will not, without the consent of the client enter into any discussion of correspondence with any third party concerning the contents of the report.

In the event of the improper use of the report. The SHENZHEN TIMEWAY TESTING LABORATORIES, reserves the rights to withdraw it and to adopt any other remedies which may be appropriate.





Current Transformer	MC2630	--	EM TEST	2017.06.11	1 Year
Magnetic Coil	MS100	0304-42	EM TEST	2017.06.11	1 Year

#### 2.10 Voltage Dips/Interruption Immunity Test

Name	Model No.	Serial No.	Manufacturer	Calibration Date	Calibration Cycle
Ultra Compact Simulator	UCS 500 M4	0304-42	EM TEST	2017.06.11	1Year
Power Source	MV2616	0104-14	EM TEST	2017.06.11	1Year

The report refers only to the sample tested and does not apply to the bulk.

This report is issued in confidence to the client and it will be strictly treated as such by the SHENZHEN TIMEWAY TESTING LABORATORIES. It may not be reproduced rather in its entirety or in part and it may not be used for advertising. The client to whom the report is issued may, however, show or send it . or a certified copy there of prepared by the SHENZHEN TIMEWAY TESTING LABORATORIES. to his customer. Supplier or others persons directly concerned. SHENZHEN TIMEWAY TESTING LABORATORIES. will not, without the consent of the client enter into any discussion of correspondence with any third party concerning the contents of the report.

In the event of the improper use of the report. The SHENZHEN TIMEWAY TESTING LABORATORIES. reserves the rights to withdraw it and to adopt any other remedies which may be appropriate.



### 3.0 Technical Details

#### 3.1 Investigations Requested

Perform Electromagnetic Interference [EMI] & Electromagnetic Susceptibility [EMS] tests for CE Marking

#### 3.2 Test Standards

Test Standards		
EN 55015: 2013+A1:2015	Limits and methods of measurement of radio disturbance characteristics of electrical lighting and similar equipment	
EN 61000-3-2: 2014	Electromagnetic compatibility(EMC)- Part 3-2:Limits-Limits for harmonic current emissions(equipment input current $\leq 16A$ per phase)	
EN61000-3-3: 2013	Electromagnetic compatibility (EMC)- Part 3-3:Limits-Limitation of voltage changes, Voltage fluctuations and flicker in public low-voltage supply systems. For equipment with rated current $\leq 16A$ per phase and not subject to conditional connection	
EN 61547: 2009	Equipment for general lighting purposes—EMC immunity requirements	
	EN 61000-4-2:2009	Electrostatic discharge
	EN 61000-4-3:2006	RF field strength susceptibility
	EN 61000-4-4:2012	Electrical Fast transients
	EN 61000-4-5:2014	Surge
	EN 61000-4-6:2009	Conducted susceptibility
	EN 61000-4-8:2010	Magnetic Field
	EN 61000-4-11:2004	Dips/Voltage Interruption Variation

The report refers only to the sample tested and does not apply to the bulk.

This report is issued in confidence to the client and it will be strictly treated as such by the SHENZHEN TIMEWAY TESTING LABORATORIES. It may not be reproduced rather in its entirety or in part and it may not be used for advertising. The client to whom the report is issued may, however, show or send it, or a certified copy thereof prepared by the SHENZHEN TIMEWAY TESTING LABORATORIES, to his customer, Supplier or others persons directly concerned. SHENZHEN TIMEWAY TESTING LABORATORIES, will not, without the consent of the client enter into any discussion of correspondence with any third party concerning the contents of the report.

In the event of the improper use of the report, The SHENZHEN TIMEWAY TESTING LABORATORIES, reserves the rights to withdraw it and to adopt any other remedies which may be appropriate.



#### 4.0 Disturbance Voltage Test

##### 4.1 Schematics of the test

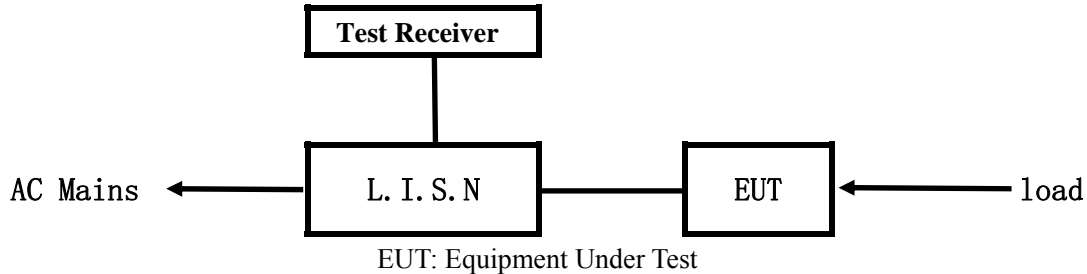

##### 4.2 Test Method:

The test was performed in accordance with EN 55015: 2013+A1:2015

Block diagram of Test setup

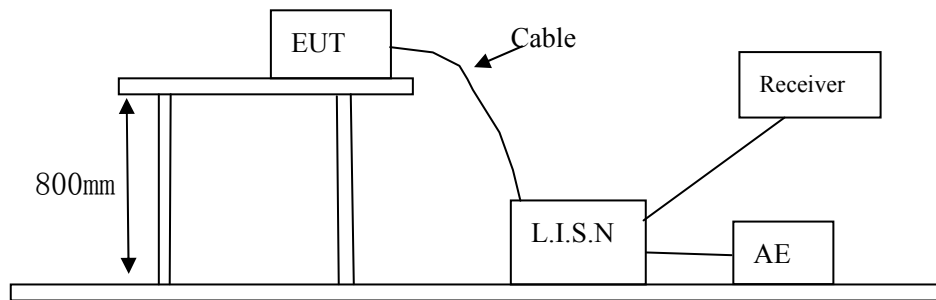

##### 4.3 Disturbance Voltage Limits

###### A Disturbance Voltage Limits at mains terminals

Frequency(MHz)	Limits dB( $\mu$ V)	
	Quasi-peak Level	Average Level
9kHz to 50kHz	110	--
50kHz to 150kHz	90 to 80	--
150kHz to 0.5MHz	66 to 56	56 to 46
0.5MHz to 2.51MHz	56	46
2.51MHz to 3.0MHz	73	63
3.0MHz to 5.0MHz	56	46
5.0MHz to 30.0MHz	60	50

Notes: 1. decreasing linearly with logarithm of the frequency in the range 50kHz to 150kHz and 150kHz to 0.5MHz.

2. The lower limit shall apply at the transition frequencies

###### B Disturbance Voltage Limits at load terminals

The report refers only to the sample tested and does not apply to the bulk.

This report is issued in confidence to the client and it will be strictly treated as such by the SHENZHEN TIMEWAY TESTING LABORATORIES. It may not be reproduced rather in its entirety or in part and it may not be used for advertizing. The client to whom the report is issued may, however, show or send it . or a certified copy there of prepared by the SHENZHEN TIMEWAY TESTING LABORATORIES. to his customer. Supplier or others persons directly concerned. SHENZHEN TIMEWAY TESTING LABORATORIES. will not, without the consent of the client enter into any discussion of correspondence with any third party concerning the contents of the report.

In the event of the improper use of the report. The SHENZHEN TIMEWAY TESTING LABORATORIES. reserves the rights to withdraw it and to adopt any other remedies which may be appropriate.



Frequency(MHz)	Limits dB( $\mu$ V)	
	Quasi-peak Level	Average Level
0.15MHz to 0.50MHz	80	70
0.50MHz to 30MHz	74	64

\*At the transition frequency, the lower limit applies.

C Disturbance Voltage Limits at Control terminals

Frequency(MHz)	Limits dB( $\mu$ V)	
	Quasi-peak Level	Average Level
0.15MHz to 0.50MHz	84 to 74	74 to 64
0.50MHz to 30MHz	74	64

\* The limits decrease linearly with the logarithm of the frequency in the range 0.15MHz to 0.5MHz

4.4 Test Results

Limits for Conducted Emission test, Please refer to limit line (Quasi-peak) in the following diagram labelled as (QP)

The report refers only to the sample tested and does not apply to the bulk.

This report is issued in confidence to the client and it will be strictly treated as such by the SHENZHEN TIMEWAY TESTING LABORATORIES. It may not be reproduced rather in its entirety or in part and it may not be used for advertising. The client to whom the report is issued may, however, show or send it . or a certified copy there of prepared by the SHENZHEN TIMEWAY TESTING LABORATORIES. to his customer. Supplier or others persons directly concerned. SHENZHEN TIMEWAY TESTING LABORATORIES. will not, without the consent of the client enter into any discussion of correspondence with any third party concerning the contents of the report.

In the event of the improper use of the report. The SHENZHEN TIMEWAY TESTING LABORATORIES. reserves the rights to withdraw it and to adopt any other remedies which may be appropriate.





**A: Disturbance Voltage Limits at mains terminals (9kHz to 30MHz)**

**EUT Operating Environment**

Temperature: 26°C      Humidity: 65%RH      Atmospheric Pressure: 101 KPa

EUT set Condition: Charging

**Results: N/A**

Please refer to following diagram for individual

The report refers only to the sample tested and does not apply to the bulk.

This report is issued in confidence to the client and it will be strictly treated as such by the SHENZHEN TIMEWAY TESTING LABORATORIES. It may not be reproduced rather in its entirety or in part and it may not be used for advertising. The client to whom the report is issued may, however, show or send it . or a certified copy there of prepared by the SHENZHEN TIMEWAY TESTING LABORATORIES. to his customer. Supplier or others persons directly concerned. SHENZHEN TIMEWAY TESTING LABORATORIES. will not, without the consent of the client enter into any discussion of correspondence with any third party concerning the contents of the report.

In the event of the improper use of the report. The SHENZHEN TIMEWAY TESTING LABORATORIES. reserves the rights to withdraw it and to adopt any other remedies which may be appropriate.



**B: Disturbance Voltage Limits at Load terminals (150kHz to 30MHz)**

**EUT Operating Environment**

Temperature: 26°C      Humidity: 65%RH      Atmospheric Pressure: 101 KPa

EUT set Condition: Charging

**Results: N/A**

Please refer to following diagram for individual

The report refers only to the sample tested and does not apply to the bulk.

This report is issued in confidence to the client and it will be strictly treated as such by the SHENZHEN TIMEWAY TESTING LABORATORIES. It may not be reproduced rather in its entirety or in part and it may not be used for advertising. The client to whom the report is issued may, however, show or send it . or a certified copy there of prepared by the SHENZHEN TIMEWAY TESTING LABORATORIES. to his customer. Supplier or others persons directly concerned. SHENZHEN TIMEWAY TESTING LABORATORIES. will not, without the consent of the client enter into any discussion of correspondence with any third party concerning the contents of the report.

In the event of the improper use of the report. The SHENZHEN TIMEWAY TESTING LABORATORIES. reserves the rights to withdraw it and to adopt any other remedies which may be appropriate.



## 5.0 Radiated electromagnetic disturbances

### 5.1 Schematics of the test



### 5.2 Test Method:

The test was performed in accordance with EN 55015: 2013+A1:2015

#### Block diagram of Test setup

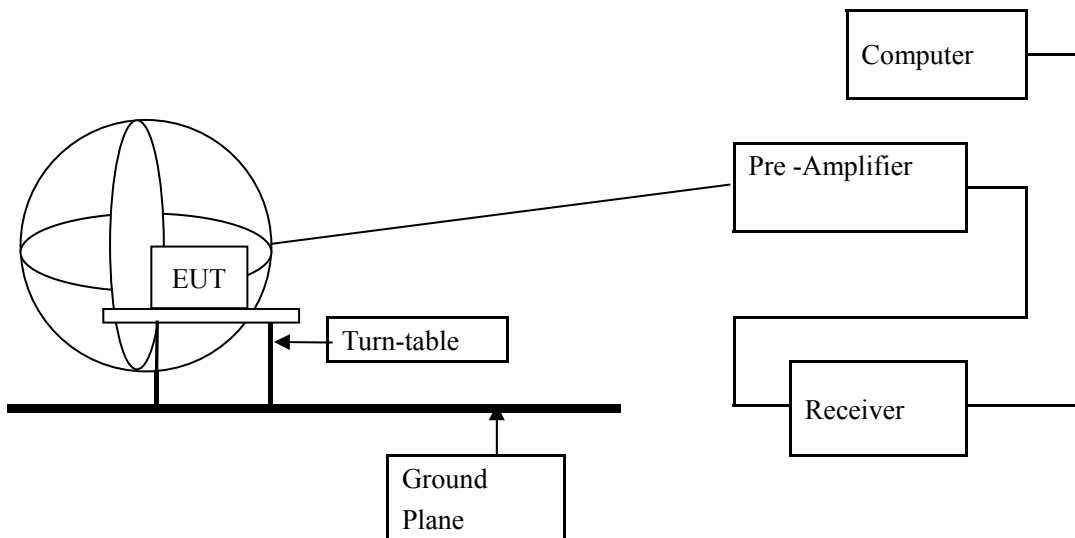

### 5.3 Radiated electromagnetic disturbances Limits

Frequency Range (MHz)	Limits for loop diameter (dB $\mu$ A)		
	2m	3m	4m
9kHz to 70kHz	88	81	75
70kHz to 150kHz	88 to 58	81 to 51	75 to 45
150kHz to 2.2MHz	58 to 26	51 to 22	45 to 16
2.2MHz to 3.0MHz	58	51	45
3.0Hz to 30MHz	22	15 to 16	9 to 12

Note: 1. The lower limit shall apply at the transition frequencies

2. Decreasing linearly with the logarithm of the frequency.

3. Increasing linearly with the logarithm of the frequency.

The report refers only to the sample tested and does not apply to the bulk.

This report is issued in confidence to the client and it will be strictly treated as such by the SHENZHEN TIMEWAY TESTING LABORATORIES. It may not be reproduced in its entirety or in part and it may not be used for advertising. The client to whom the report is issued may, however, show or send it, or a certified copy thereof prepared by the SHENZHEN TIMEWAY TESTING LABORATORIES, to his customer. Supplier or others persons directly concerned. SHENZHEN TIMEWAY TESTING LABORATORIES, will not, without the consent of the client enter into any discussion of correspondence with any third party concerning the contents of the report.

In the event of the improper use of the report, the SHENZHEN TIMEWAY TESTING LABORATORIES, reserves the rights to withdraw it and to adopt any other remedies which may be appropriate.



5.4 Radiated electromagnetic disturbances in X (9kHz to 30MHz)

EUT set Condition: ON

**Results: Pass**

Please refer to following diagram for individual

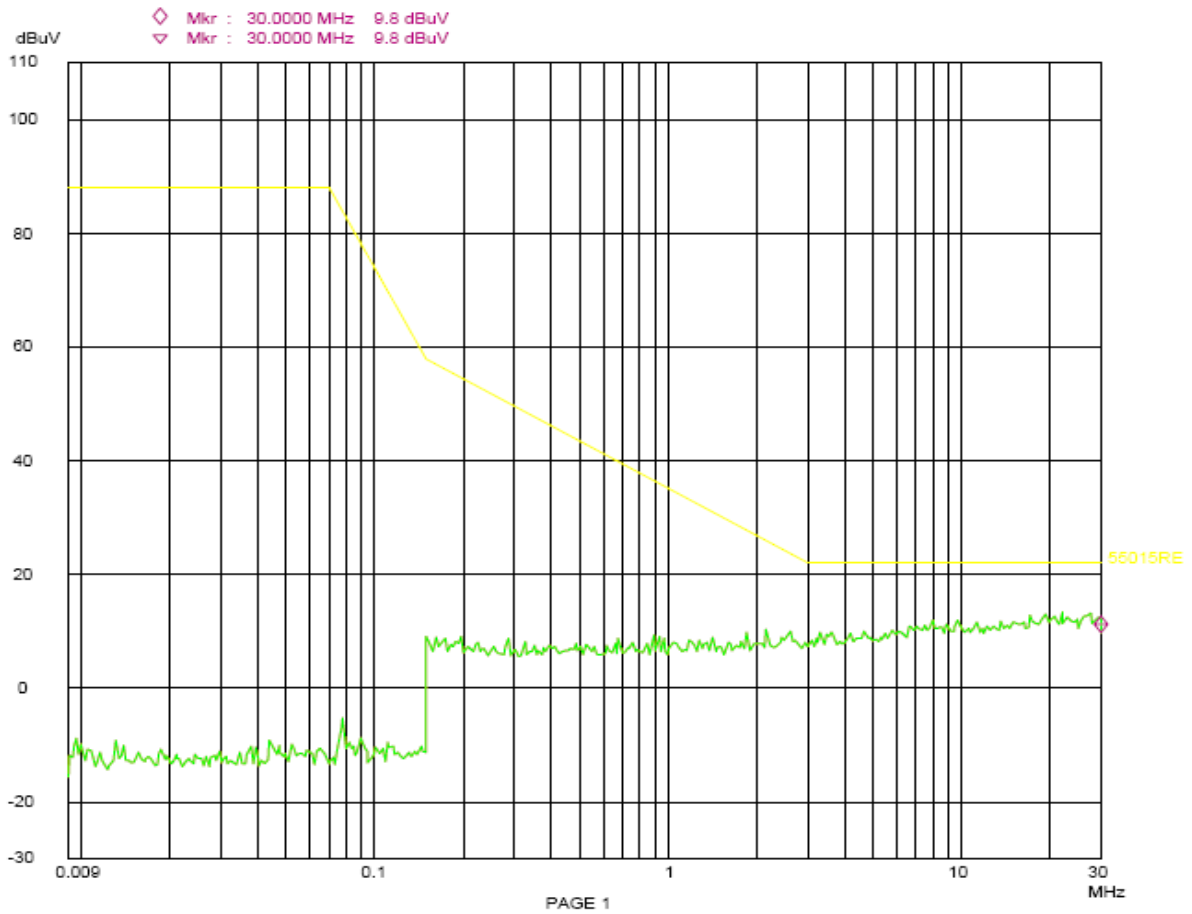

Frequency (MHz)	Level (dBμA)	field directions	Limit (dBμV/m)
-	-	X	-
-	-	X	-

The test data shows much less than the limit, no necessary take the results.

The report refers only to the sample tested and does not apply to the bulk.

This report is issued in confidence to the client and it will be strictly treated as such by the SHENZHEN TIMEWAY TESTING LABORATORIES. It may not be reproduced rather in its entirety or in part and it may not be used for adverting. The client to whom the report is issued may, however, show or send it . or a certified copy there of prepared by the SHENZHEN TIMEWAY TESTING LABORATORIES. to his customer. Supplier or others persons directly concerned. SHENZHEN TIMEWAY TESTING LABORATORIES. will not, without the consent of the client enter into any discussion of correspondence with any third party concerning the contents of the report.

In the event of the improper use of the report. The SHENZHEN TIMEWAY TESTING LABORATORIES. reserves the rights to withdraw it and to adopt any other remedies which may be appropriate.





**Radiated electromagnetic disturbances in Y (9kHz to 30MHz)**

EUT set Condition: ON

**Results: Pass**

Please refer to following diagram for individual

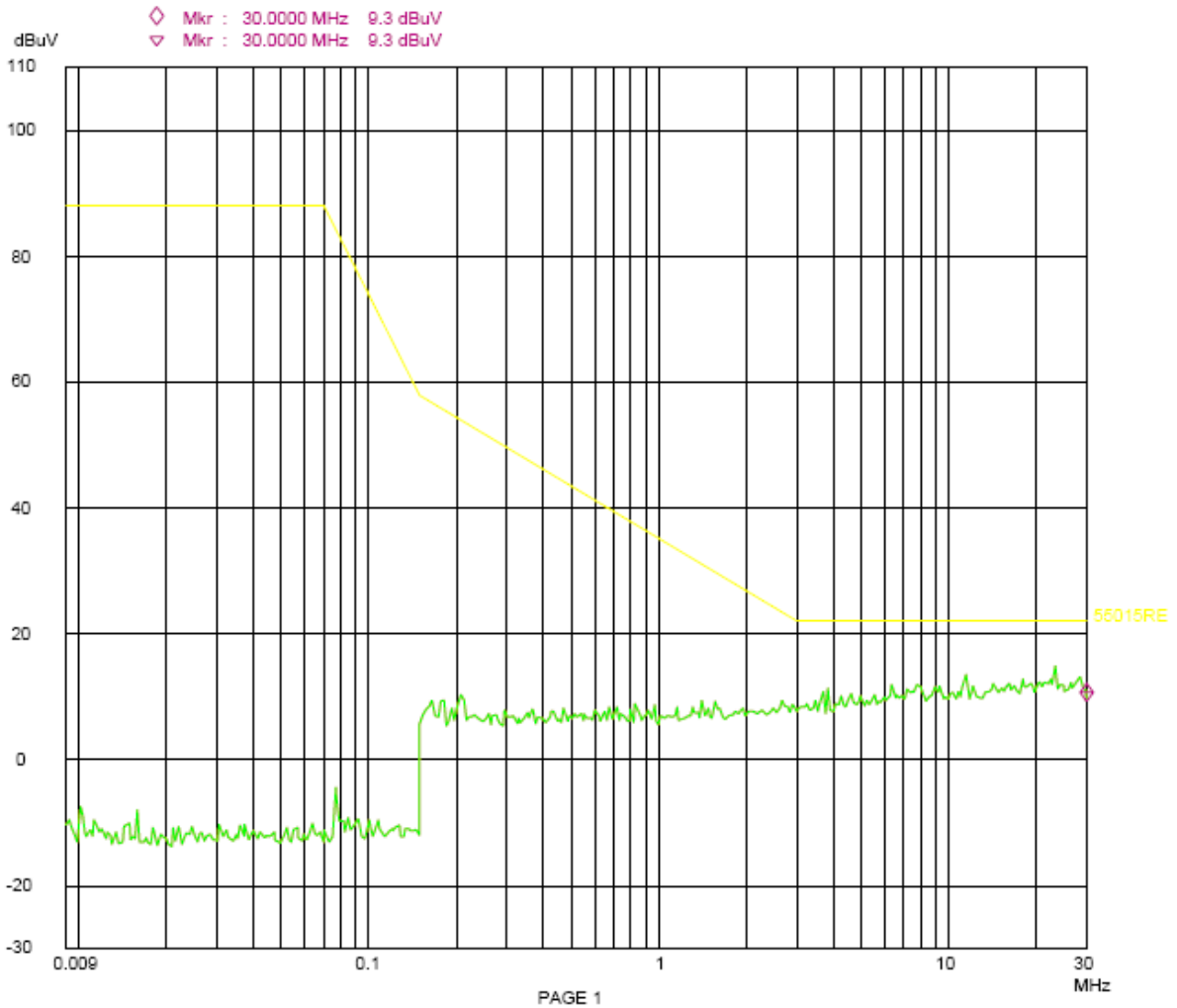

Frequency (MHz)	Level (dB $\mu$ A)	field directions	Limit (dB $\mu$ V/m)
-	-	Y	-
-	-	Y	-

The test data shows much less than the limit, no necessary take the results.

The report refers only to the sample tested and does not apply to the bulk.

This report is issued in confidence to the client and it will be strictly treated as such by the SHENZHEN TIMEWAY TESTING LABORATORIES. It may not be reproduced rather in its entirety or in part and it may not be used for advertising. The client to whom the report is issued may, however, show or send it, or a certified copy thereof prepared by the SHENZHEN TIMEWAY TESTING LABORATORIES, to his customer, Supplier or others persons directly concerned. SHENZHEN TIMEWAY TESTING LABORATORIES, will not, without the consent of the client enter into any discussion of correspondence with any third party concerning the contents of the report.

In the event of the improper use of the report, The SHENZHEN TIMEWAY TESTING LABORATORIES, reserves the rights to withdraw it and to adopt any other remedies which may be appropriate.



**Radiated electromagnetic disturbances in Z (9kHz to 30MHz)**

EUT set Condition: ON

**Results: Pass**

Please refer to following diagram for individual

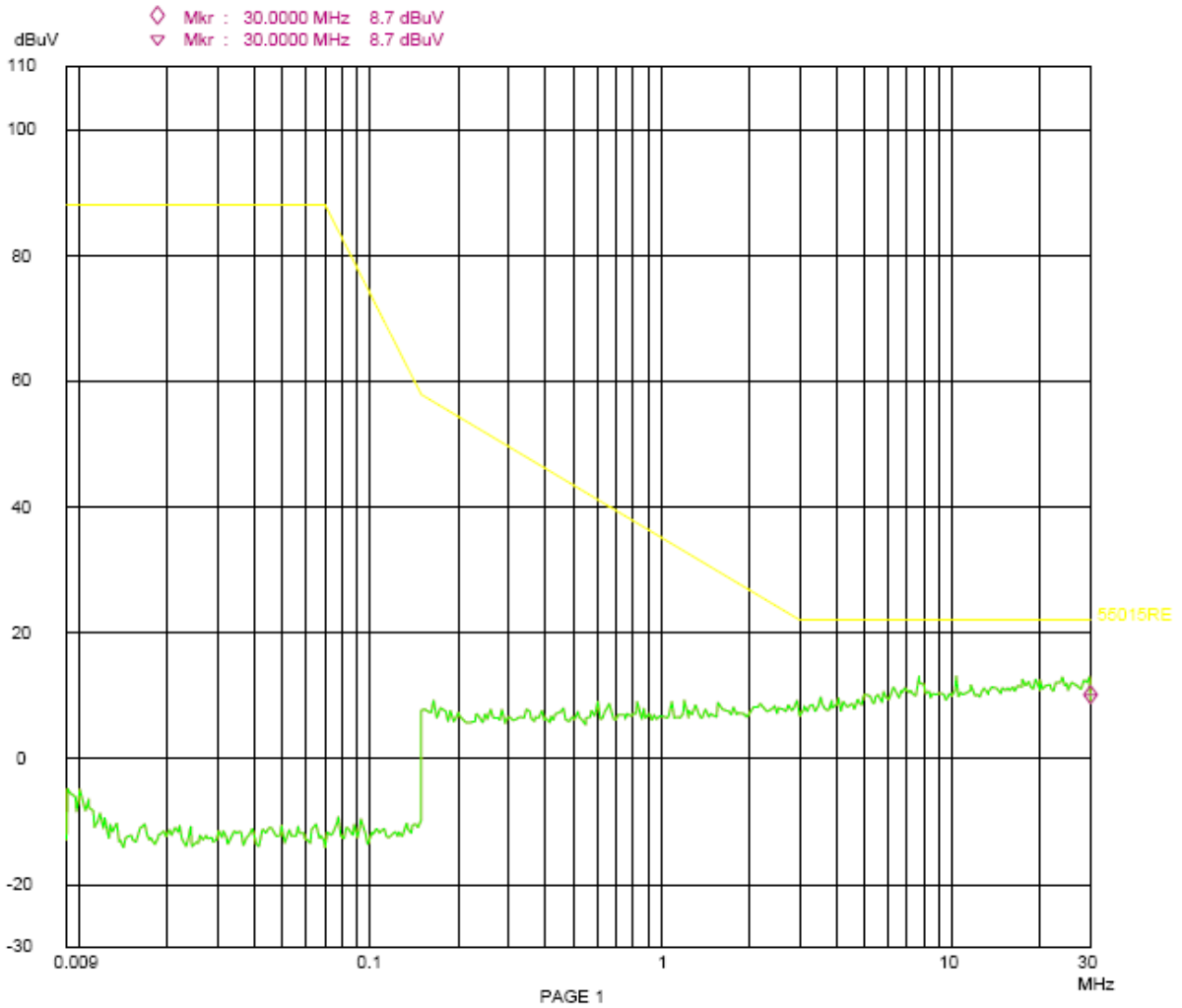

Frequency (MHz)	Level (dB $\mu$ A)	field directions	Limit (dB $\mu$ V/m)
-	-	Z	-
-	-	Z	-

The test data shows much less than the limit, no necessary take the results.

The report refers only to the sample tested and does not apply to the bulk.

This report is issued in confidence to the client and it will be strictly treated as such by the SHENZHEN TIMEWAY TESTING LABORATORIES. It may not be reproduced rather in its entirety or in part and it may not be used for advertising. The client to whom the report is issued may, however, show or send it . or a certified copy there of prepared by the SHENZHEN TIMEWAY TESTING LABORATORIES. to his customer. Supplier or others persons directly concerned. SHENZHEN TIMEWAY TESTING LABORATORIES. will not, without the consent of the client enter into any discussion of correspondence with any third party concerning the contents of the report.

In the event of the improper use of the report. The SHENZHEN TIMEWAY TESTING LABORATORIES. reserves the rights to withdraw it and to adopt any other remedies which may be appropriate.



**6.0 Radiated Disturbance Test**

6.1 Schematics of the test



6.2 Test Method:

The test was performed in accordance with EN 55015: 2013+A1:2015

**Block diagram of Test setup**

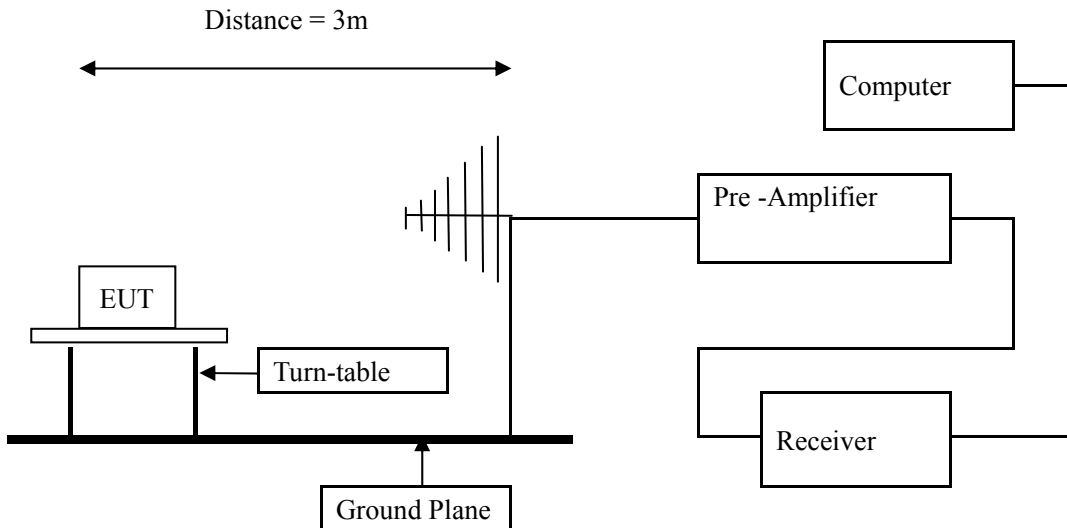

6.3 Power line conducted Emission Limit

Frequency Range (MHz)	Quasi-Peak limits (dB $\mu$ V/m)
30-230	40.00
230-300	47.00

Note: The lower limit shall apply at the transition frequencies

6.4 Test result

Please refer to following table

The report refers only to the sample tested and does not apply to the bulk.  
 This report is issued in confidence to the client and it will be strictly treated as such by the SHENZHEN TIMEWAY TESTING LABORATORIES. It may not be reproduced rather in its entirety or in part and it may not be used for advertising. The client to whom the report is issued may, however, show or send it, or a certified copy thereof prepared by the SHENZHEN TIMEWAY TESTING LABORATORIES, to his customer, supplier or others persons directly concerned. SHENZHEN TIMEWAY TESTING LABORATORIES, will not, without the consent of the client enter into any discussion of correspondence with any third party concerning the contents of the report.  
 In the event of the improper use of the report, The SHENZHEN TIMEWAY TESTING LABORATORIES, reserves the rights to withdraw it and to adopt any other remedies which may be appropriate.



**A: Radiated Disturbance In Horizontal (30MHz----1000MHz)**

EUT set Condition: ON

**Results: Pass**

Please refer to following diagram for individual

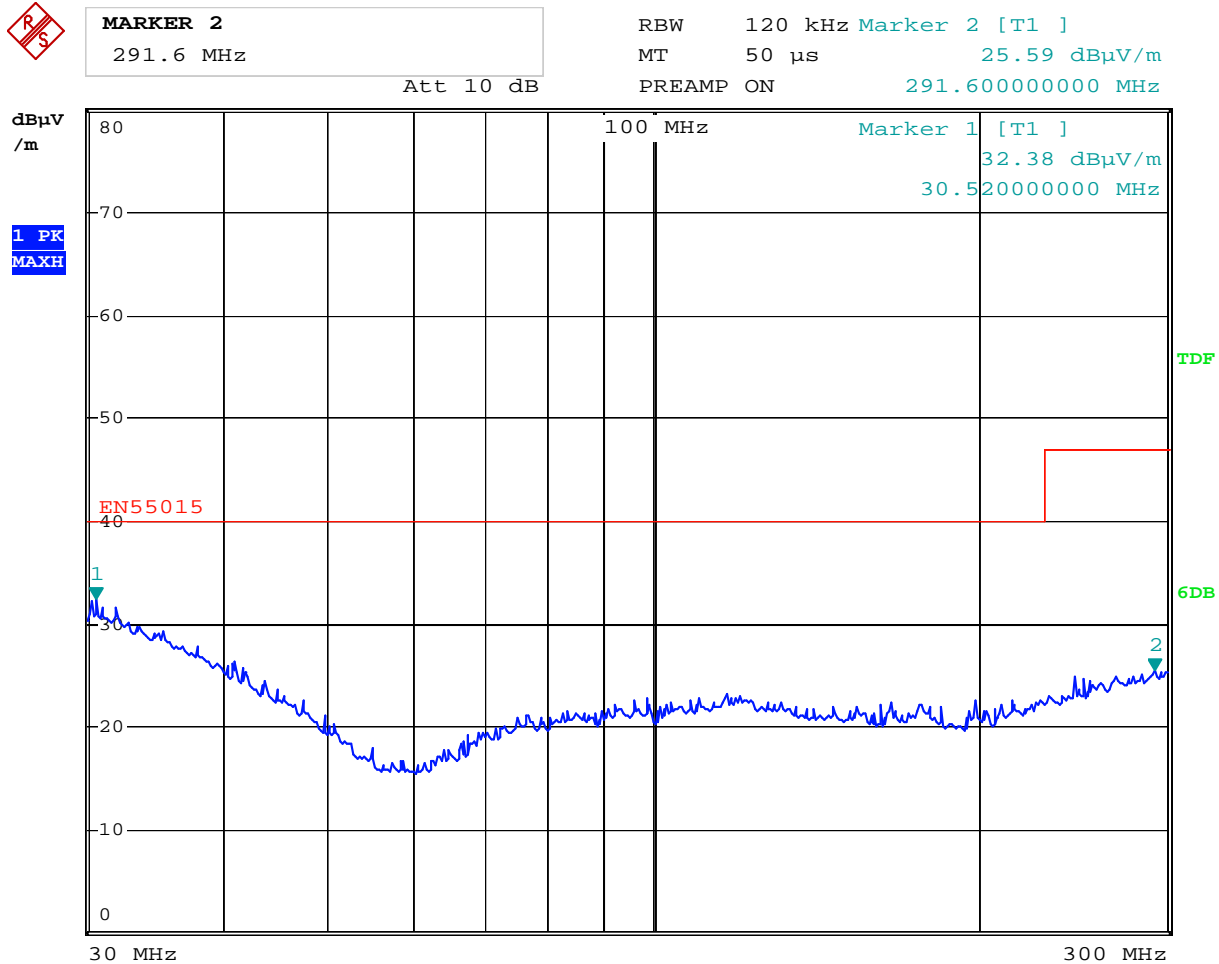

Date: 9.APR.2018 16:49:49

Frequency (MHz)	Level@3m (dB μ V/m)	Antenna Polarity	Limit@3m (dB μ /m)
291.600	25.59	H	47.00
30.520	32.38	H	40.00

The report refers only to the sample tested and does not apply to the bulk.  
 This report is issued in confidence to the client and it will be strictly treated as such by the SHENZHEN TIMEWAY TESTING LABORATORIES. It may not be reproduced rather in its entirety or in part and it may not be used for advertising. The client to whom the report is issued may, however, show or send it . or a certified copy there of prepared by the SHENZHEN TIMEWAY TESTING LABORATORIES. to his customer. Supplier or others persons directly concerned. SHENZHEN TIMEWAY TESTING LABORATORIES. will not, without the consent of the client enter into any discussion of correspondence with any third party concerning the contents of the report.  
 In the event of the improper use of the report. The SHENZHEN TIMEWAY TESTING LABORATORIES. reserves the rights to withdraw it and to adopt any other remedies which may be appropriate.





**B: Radiated Disturbance In Vertical (30MHz----1000MHz)**

EUT set Condition: ON

**Results: Pass**

Please refer to following diagram for individual

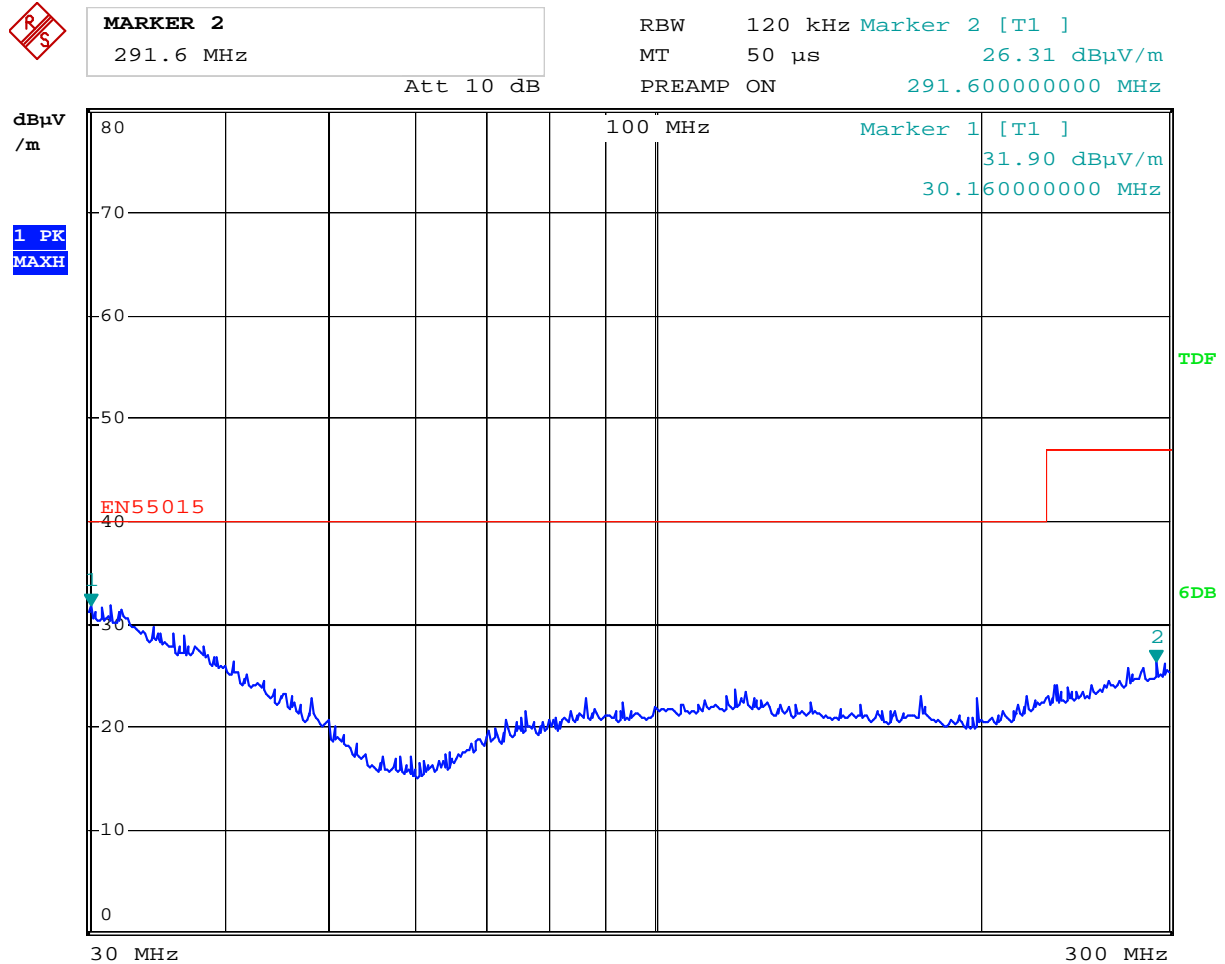

Date: 9.APR.2018 16:55:05

Frequency (MHz)	Level@3m (dBµV/m)	Antenna Polarity	Limit@3m (dBµV/m)
291.600	26.31	V	47.00
30.160	31.90	V	40.00

The report refers only to the sample tested and does not apply to the bulk.  
 This report is issued in confidence to the client and it will be strictly treated as such by the SHENZHEN TIMEWAY TESTING LABORATORIES. It may not be reproduced rather in its entirety or in part and it may not be used for advertising. The client to whom the report is issued may, however, show or send it . or a certified copy there of prepared by the SHENZHEN TIMEWAY TESTING LABORATORIES. to his customer. Supplier or others persons directly concerned. SHENZHEN TIMEWAY TESTING LABORATORIES. will not, without the consent of the client enter into any discussion of correspondence with any third party concerning the contents of the report.  
 In the event of the improper use of the report. The SHENZHEN TIMEWAY TESTING LABORATORIES. reserves the rights to withdraw it and to adopt any other remedies which may be appropriate.



## 7.0 Voltage Fluctuations & Flicker Test

### 7.1 Schematic of the test

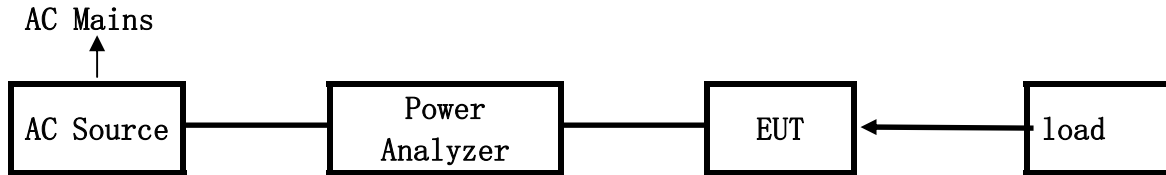

EUT: Equipment Under Test

### 7.2 Test Method:

The test was performed in accordance with EN 61000-3-3: 2013

### 7.3 Test Results

Result: N/A

N/A ---DC Operation

Please refer to the following pages

#### Maximum Occurring Levels:

Ut: 230.01 (EUT Test RMS Voltage)

Pst:	Limit=	1.0	(The Highest short Term Flicker Value)
Plt:	Limit=	0.65	(The Highest Long Term Flicker Value)
dt(%):	Limit=	3.3%	(The Highest instantaneous Voltage Change (10ms))
dc(%):	Limit=	3.3%	(The highest Relative steady state voltage change (1sec))
dmax:	Limit=	4%	(The highest Max Relative voltage change)
Tdt:	Limit=	500ms	( The Max Time(in milli-sec) that dt exceeds 3%)

The report refers only to the sample tested and does not apply to the bulk.

This report is issued in confidence to the client and it will be strictly treated as such by the SHENZHEN TIMEWAY TESTING LABORATORIES. It may not be reproduced rather in its entirety or in part and it may not be used for advertising. The client to whom the report is issued may, however, show or send it, or a certified copy thereof prepared by the SHENZHEN TIMEWAY TESTING LABORATORIES, to his customer, supplier or others persons directly concerned. SHENZHEN TIMEWAY TESTING LABORATORIES, will not, without the consent of the client enter into any discussion of correspondence with any third party concerning the contents of the report.

In the event of the improper use of the report, the SHENZHEN TIMEWAY TESTING LABORATORIES, reserves the rights to withdraw it and to adopt any other remedies which may be appropriate.



**8.0 Harmonic Current Emission Test**

8.1 Schematic of the test

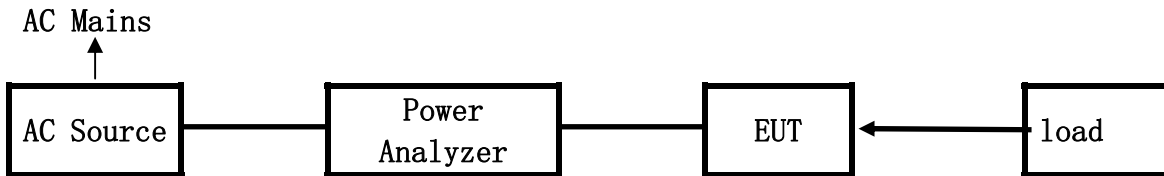

EUT: Equipment Under Test

8.2 Test Method

The test was performed in accordance with EN 61000-3-2: 2014

\*: The Level of the product is: CLASS C

8.3 Test Results: N/A

N/A ---DC Operation

Rating:

Harmonic results as a% of the limits

No	(Test result/Limit)%	No	(Test result/Limit)%	No	(Test result/Limit)%	No	(Test result/Limit)%
1	--	11	--	21	--	31	--
2	--	12	--	22	--	32	--
3		13	--	23	--	33	--
4		14	--	24	--	34	--
5		15	--	25	--	35	--
6		16	--	26	--	36	--
7	--	17	--	27	--	37	--
8	--	18	--	28	--	38	--
9	--	19	--	29	--	39	--
10	--	20	--	30	--	40	--

The report refers only to the sample tested and does not apply to the bulk.

This report is issued in confidence to the client and it will be strictly treated as such by the SHENZHEN TIMEWAY TESTING LABORATORIES. It may not be reproduced rather in its entirety or in part and it may not be used for advertising. The client to whom the report is issued may, however, show or send it, or a certified copy thereof prepared by the SHENZHEN TIMEWAY TESTING LABORATORIES, to his customer, Supplier or others persons directly concerned. SHENZHEN TIMEWAY TESTING LABORATORIES, will not, without the consent of the client enter into any discussion of correspondence with any third party concerning the contents of the report.

In the event of the improper use of the report, The SHENZHEN TIMEWAY TESTING LABORATORIES, reserves the rights to withdraw it and to adopt any other remedies which may be appropriate.



## 9.0 Electrostatic Discharge

### 9.1 Schematic of the test

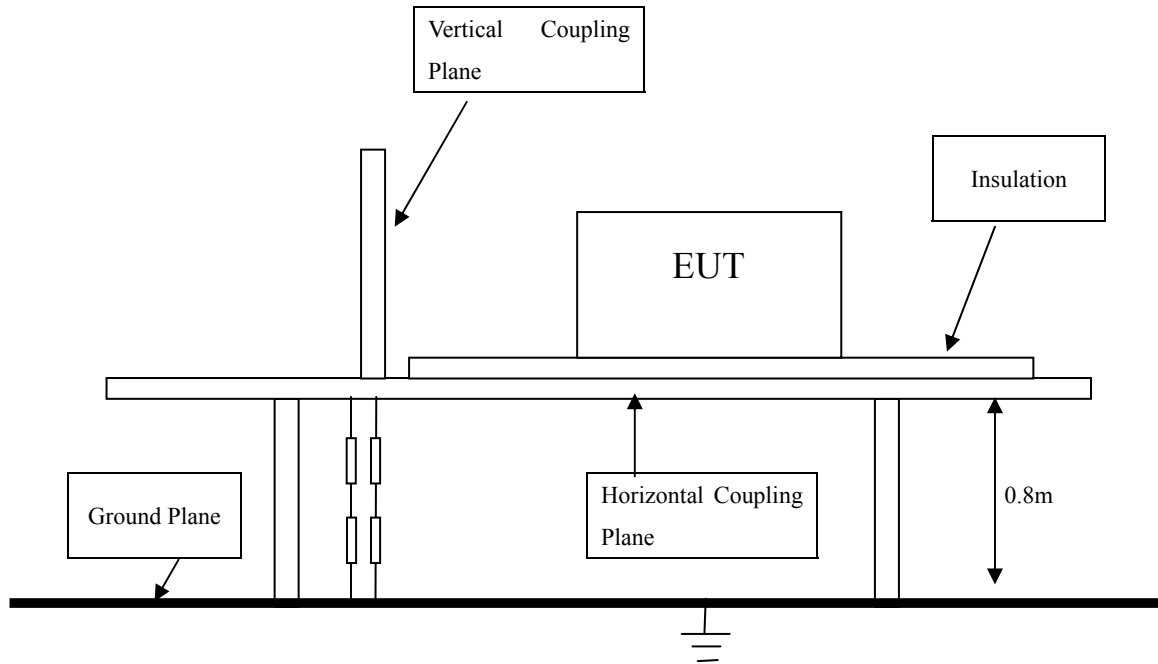

### 9.2 Test method

The test was performed in accordance with EN 61000-4-2:2009

### 9.3 Test severity

±4kV for direct & in-direct Contact Discharge

±8kV for air Discharge

Performance Criterion Require: B (Please see following table)

### 9.4 Susceptibility performance Criteria and Severity level

A	Normal performance within the specification limits
B	Temporary degradation or loss of function or performance which is self recoverable
C	Temporary degradation or loss of function or performance which requires operator intervention or system reset
D	Degradation or loss of function which is not recoverable due to damage of equipment(components) or software, or loss of data

The report refers only to the sample tested and does not apply to the bulk.

This report is issued in confidence to the client and it will be strictly treated as such by the SHENZHEN TIMEWAY TESTING LABORATORIES. It may not be reproduced rather in its entirety or in part and it may not be used for advertising. The client to whom the report is issued may, however, show or send it, or a certified copy thereof prepared by the SHENZHEN TIMEWAY TESTING LABORATORIES, to his customer, supplier or other persons directly concerned. SHENZHEN TIMEWAY TESTING LABORATORIES, will not, without the consent of the client enter into any discussion of correspondence with any third party concerning the contents of the report.

In the event of the improper use of the report, the SHENZHEN TIMEWAY TESTING LABORATORIES, reserves the rights to withdraw it and to adopt any other remedies which may be appropriate.



Severity Level

Level	Test Voltage Direct & in-direct contact Discharge (kV)	Test Voltage Air discharge(kV)
1	±2kV	±2kV
2	±4kV	±4kV
3	±6kV	±8kV
4	±8kV	±15kV

9.5 Test Result

Please refer to the following table for individual results.

Location	Discharge Method	Test Voltage	Results
HCP (Horizontal coupling plane)	In-Direct	±2kV, ±4kV	Pass
VCP (Vertical Coupling plane)	In-Direct	±4kV ±4kV	Pass
Shell	In-Direct	±2kV, ±4kV	Pass
Shell	Air Discharge	±2kV, ±4kV, ±8kV	Pass
Gap	Air Discharge	±2kV, ±4kV, ±8kV	Pass
Cable	Air Discharge	±2kV, ±4kV, ±8kV	Pass
Connector	Air Discharge	±2kV, ±4kV, ±8kV	Pass

Remark: Calculated measurement uncertainty= 0.2kV

The report refers only to the sample tested and does not apply to the bulk.

This report is issued in confidence to the client and it will be strictly treated as such by the SHENZHEN TIMEWAY TESTING LABORATORIES. It may not be reproduced rather in its entirety or in part and it may not be used for advertising. The client to whom the report is issued may, however, show or send it . or a certified copy there of prepared by the SHENZHEN TIMEWAY TESTING LABORATORIES. to his customer. Supplier or others persons directly concerned. SHENZHEN TIMEWAY TESTING LABORATORIES. will not, without the consent of the client enter into any discussion of correspondence with any third party concerning the contents of the report.

In the event of the improper use of the report. The SHENZHEN TIMEWAY TESTING LABORATORIES. reserves the rights to withdraw it and to adopt any other remedies which may be appropriate.



**10.0 RF field strength susceptibility (80MHz----- 1000MHz)**

10.1 Schematics of the test



10.2 Test Method:

The test was performed in accordance with EN 61000-4-3: 2006

Severity: Level 2 (3V/m)

Modulation: 80% AM

Performance Criterion Require: A (Please see following table)

**Block diagram of Test setup**

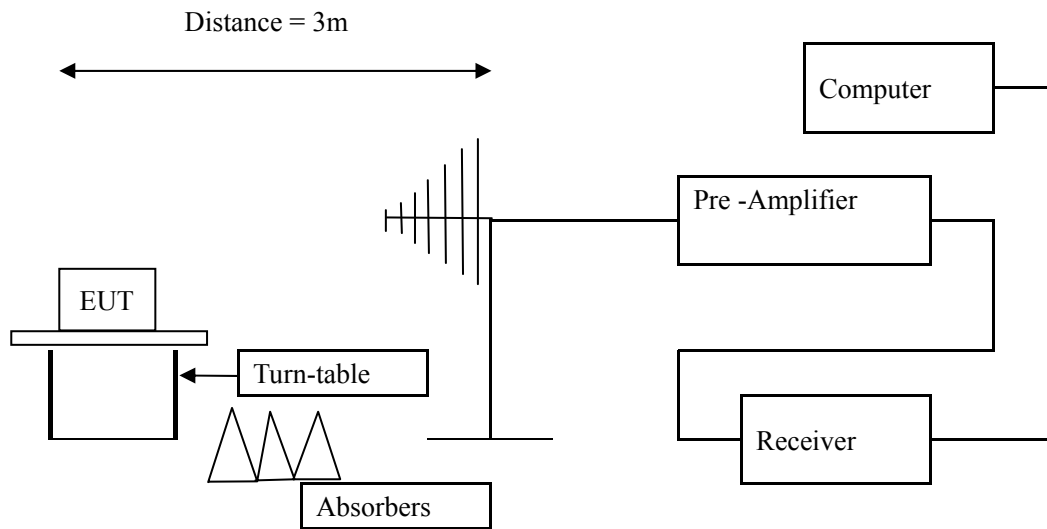

10.3 Susceptibility performance Criteria and severity Level

Susceptibility performance Criteria

A	Normal performance within the specification limits
B	Temporary degradation or loss of function or performance which is self recoverable
C	Temporary degradation or loss of function or performance which requires operator intervention or system reset
D	Degradation or loss of function which is not recoverable due to damage of equipment(components) or software, or loss of data

Severity Level

The report refers only to the sample tested and does not apply to the bulk.  
 This report is issued in confidence to the client and it will be strictly treated as such by the SHENZHEN TIMEWAY TESTING LABORATORIES. It may not be reproduced in its entirety or in part and it may not be used for advertising. The client to whom the report is issued may, however, show or send it, or a certified copy thereof prepared by the SHENZHEN TIMEWAY TESTING LABORATORIES, to his customer, supplier or other persons directly concerned. SHENZHEN TIMEWAY TESTING LABORATORIES, will not, without the consent of the client enter into any discussion of correspondence with any third party concerning the contents of the report.  
 In the event of the improper use of the report, the SHENZHEN TIMEWAY TESTING LABORATORIES, reserves the rights to withdraw it and to adopt any other remedies which may be appropriate.



Level	Field Strength (V/m)
1	1
2	3
3	10

10.4 Test Result:

Please refer to the following table for individual results.

Frequency (MHz)	Face	Polarity	Level (V/m)	Dwell Time(s)	Sweep Rate (%)	Results
80-1000	0°	Horizontal	3	1	1	Pass
80-1000	90°	Horizontal	3	1	1	Pass
80-1000	180°	Horizontal	3	1	1	Pass
80-1000	270°	Horizontal	3	1	1	Pass
80-1000	0°	Vertical	3	1	1	Pass
80-1000	90°	Vertical	3	1	1	Pass
80-1000	180°	Vertical	3	1	1	Pass
80-1000	270°	Vertical	3	1	1	Pass

Remark: Calculated measurement uncertainty= 80MHz to 1000MHz (+3.7/ -1.3) V/m

The report refers only to the sample tested and does not apply to the bulk.

This report is issued in confidence to the client and it will be strictly treated as such by the SHENZHEN TIMEWAY TESTING LABORATORIES. It may not be reproduced rather in its entirety or in part and it may not be used for advertising. The client to whom the report is issued may, however, show or send it, or a certified copy thereof prepared by the SHENZHEN TIMEWAY TESTING LABORATORIES, to his customer, supplier or others persons directly concerned. SHENZHEN TIMEWAY TESTING LABORATORIES, will not, without the consent of the client enter into any discussion of correspondence with any third party concerning the contents of the report.

In the event of the improper use of the report, the SHENZHEN TIMEWAY TESTING LABORATORIES, reserves the rights to withdraw it and to adopt any other remedies which may be appropriate.





**11.0 Electrical Fast Transient/Burst (EFT/B) immunity test**

11.1 Schematics of the test



11.2 Test Method

The test was performed in accordance with EN 61000-4-4: 2012

Severity: Level 2 (1kV)

Performance Criterion Require: B (Please see following table)

**Block diagram of Test setup**

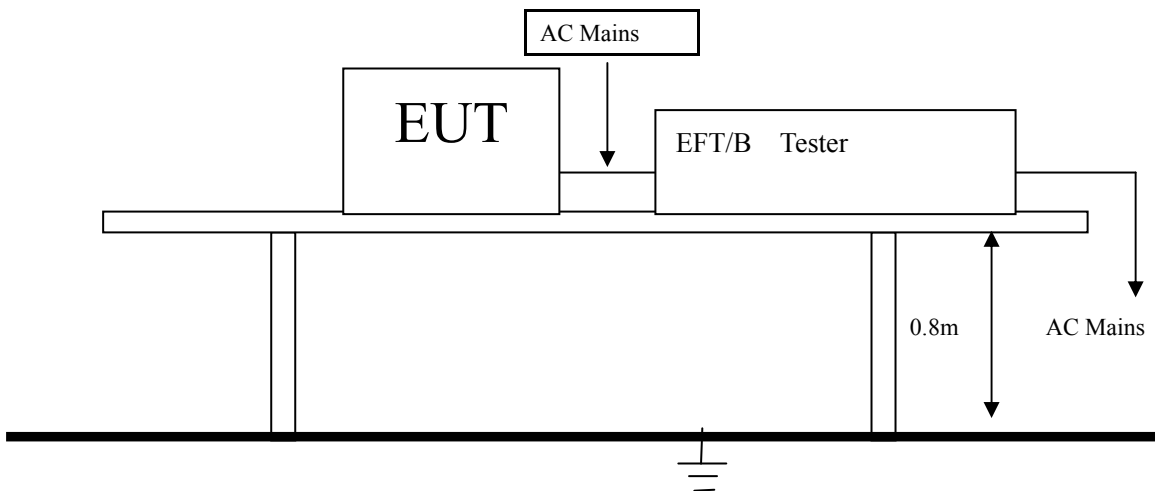

11.3 Susceptibility performance Criteria and Severity Level

Susceptibility performance Criteria

A	Normal performance within the specification limits
B	Temporary degradation or loss of function or performance which is self recoverable
C	Temporary degradation or loss of function or performance which requires operator intervention or system reset
D	Degradation or loss of function which is not recoverable due to damage of equipment(components) or software, or loss of data

The report refers only to the sample tested and does not apply to the bulk.

This report is issued in confidence to the client and it will be strictly treated as such by the SHENZHEN TIMEWAY TESTING LABORATORIES. It may not be reproduced rather in its entirety or in part and it may not be used for advertising. The client to whom the report is issued may, however, show or send it, or a certified copy thereof prepared by the SHENZHEN TIMEWAY TESTING LABORATORIES, to his customer, Supplier or others persons directly concerned. SHENZHEN TIMEWAY TESTING LABORATORIES, will not, without the consent of the client enter into any discussion of correspondence with any third party concerning the contents of the report.

In the event of the improper use of the report, The SHENZHEN TIMEWAY TESTING LABORATORIES, reserves the rights to withdraw it and to adopt any other remedies which may be appropriate.



Severity Level

Open Circuit output Test Voltage $\pm 10\%$		
Level	On power Supply Lines	On I/O (Input/output) Signal data and control lines
1	0.5kV	0.5kV
2	1kV	1kV
3	2kV	2kV
4	4kV	4kV
X	Special	Special

11.4 Test Results

Please refer to following page.

Inject location:

Inject Line	Voltage kV	Inject Times (s)	Method	Results
L	$\pm 1$	120	Direct	Pass
N	$\pm 1$	120	Direct	Pass
L-N	$\pm 1$	120	Direct	Pass

The report refers only to the sample tested and does not apply to the bulk.

This report is issued in confidence to the client and it will be strictly treated as such by the SHENZHEN TIMEWAY TESTING LABORATORIES. It may not be reproduced rather in its entirety or in part and it may not be used for advertising. The client to whom the report is issued may, however, show or send it . or a certified copy there of prepared by the SHENZHEN TIMEWAY TESTING LABORATORIES. to his customer. Supplier or others persons directly concerned. SHENZHEN TIMEWAY TESTING LABORATORIES. will not, without the consent of the client enter into any discussion of correspondence with any third party concerning the contents of the report.

In the event of the improper use of the report. The SHENZHEN TIMEWAY TESTING LABORATORIES. reserves the rights to withdraw it and to adopt any other remedies which may be appropriate.



**12.0 Surge test**

12.1 Schematics of the test



12.2 Test Method:

The test was performed in accordance with EN 61000-4-5: 2014  
 Severity: Level 2 (Below 25W Line to Neutral at 0.5kV)

Performance Criterion Require: C (Please see following table)

**Block diagram of Test setup**

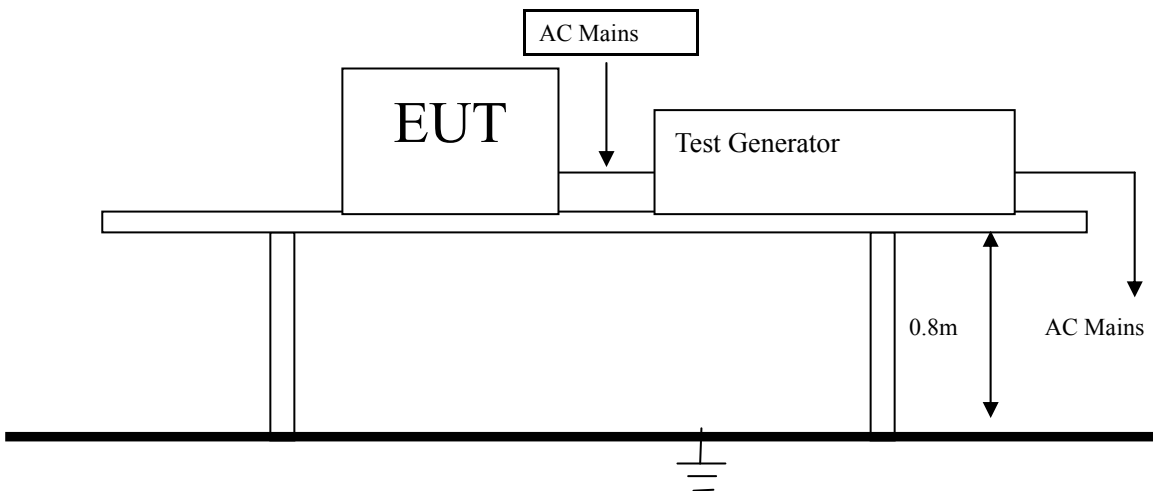

12.3 Susceptibility performance Criteria and Severity Level

Susceptibility performance Criteria

A	Normal performance within the specification limits
B	Temporary degradation or loss of function or performance which is self recoverable
C	Temporary degradation or loss of function or performance which requires operator intervention or system reset
D	Degradation or loss of function which is not recoverable due to damage of equipment(components) or software, or loss of data

The report refers only to the sample tested and does not apply to the bulk.  
 This report is issued in confidence to the client and it will be strictly treated as such by the SHENZHEN TIMEWAY TESTING LABORATORIES. It may not be reproduced rather in its entirety or in part and it may not be used for advertising. The client to whom the report is issued may, however, show or send it, or a certified copy thereof prepared by the SHENZHEN TIMEWAY TESTING LABORATORIES, to his customer, Supplier or others persons directly concerned. SHENZHEN TIMEWAY TESTING LABORATORIES, will not, without the consent of the client enter into any discussion of correspondence with any third party concerning the contents of the report.  
 In the event of the improper use of the report, The SHENZHEN TIMEWAY TESTING LABORATORIES, reserves the rights to withdraw it and to adopt any other remedies which may be appropriate.



Severity Level

Severity Level	Open-Circuit Test Voltage kV
1	0.5
2	1.0
3	2.0
4	4.0
*	Special

12.4 Test Results

Please refer to following page.

Test location:

Location	Polarity	Phase Angle	No of Pulse	Pulse Voltage(kV)	Results
L-N	+	90	10	0.5	Pass
	-	270	10	0.5	Pass

The report refers only to the sample tested and does not apply to the bulk.

This report is issued in confidence to the client and it will be strictly treated as such by the SHENZHEN TIMEWAY TESTING LABORATORIES. It may not be reproduced rather in its entirety or in part and it may not be used for advertising. The client to whom the report is issued may, however, show or send it, or a certified copy thereof prepared by the SHENZHEN TIMEWAY TESTING LABORATORIES, to his customer. Supplier or others persons directly concerned. SHENZHEN TIMEWAY TESTING LABORATORIES, will not, without the consent of the client enter into any discussion of correspondence with any third party concerning the contents of the report.

In the event of the improper use of the report. The SHENZHEN TIMEWAY TESTING LABORATORIES, reserves the rights to withdraw it and to adopt any other remedies which may be appropriate.



### 13.0 Conducted Immunity test

#### 13.1 Schematics of the test

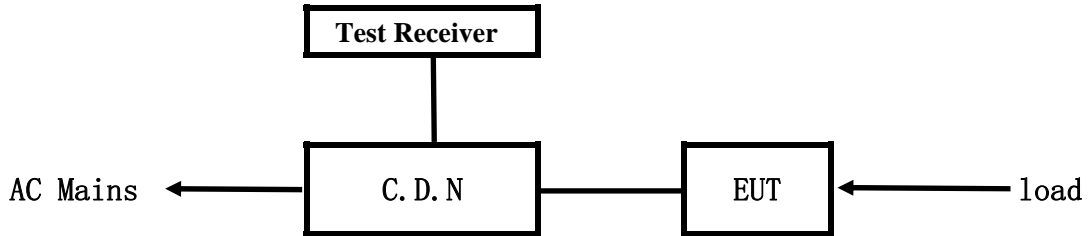

#### 13.2 Test Method

The test was performed in accordance with EN 61000-4-6: 2009

Severity: Level 2 (3 V rms), 0.15MHz—80MHz

Performance Criterion Require: A (Please see following table)

#### Block diagram of Test setup

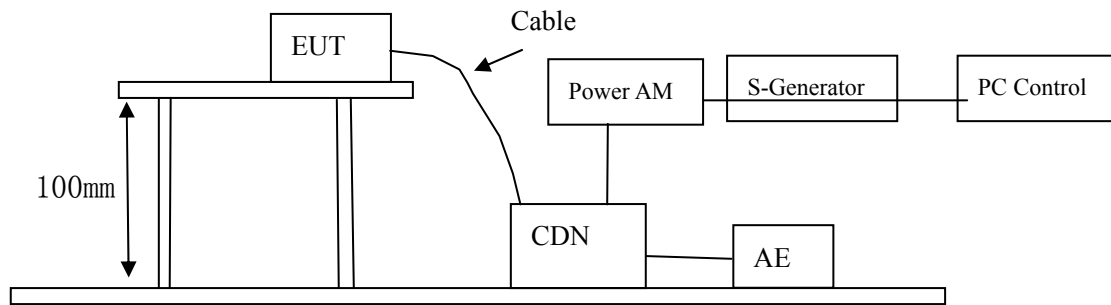

#### 13.3 Susceptibility performance Criteria and Severity Level

##### Susceptibility performance Criteria

A	Normal performance within the specification limits
B	Temporary degradation or loss of function or performance which is self recoverable
C	Temporary degradation or loss of function or performance which requires operator intervention or system reset
D	Degradation or loss of function which is not recoverable due to damage of equipment(components) or software, or loss of data

##### Severity Level

Severity Level	Field Strength V/m
1	1
2	3
3	10
*	Special

The report refers only to the sample tested and does not apply to the bulk.

This report is issued in confidence to the client and it will be strictly treated as such by the SHENZHEN TIMEWAY TESTING LABORATORIES. It may not be reproduced rather in its entirety or in part and it may not be used for advertising. The client to whom the report is issued may, however, show or send it, or a certified copy thereof prepared by the SHENZHEN TIMEWAY TESTING LABORATORIES, to his customer. Supplier or others persons directly concerned. SHENZHEN TIMEWAY TESTING LABORATORIES, will not, without the consent of the client enter into any discussion of correspondence with any third party concerning the contents of the report.

In the event of the improper use of the report. The SHENZHEN TIMEWAY TESTING LABORATORIES, reserves the rights to withdraw it and to adopt any other remedies which may be appropriate.



#### 13.4 Test Results

Please refer to the following page

Frequency Range (MHz)	Injected Position	Strength	Criterion	Result
0.15 - 20	AC Line	3V (rms) Unmodulated	A	Pass
20 - 80	AC Line	3V (rms) Unmodulated	A	Pass

The report refers only to the sample tested and does not apply to the bulk.

This report is issued in confidence to the client and it will be strictly treated as such by the SHENZHEN TIMEWAY TESTING LABORATORIES. It may not be reproduced rather in its entirety or in part and it may not be used for advertising. The client to whom the report is issued may, however, show or send it, or a certified copy thereof prepared by the SHENZHEN TIMEWAY TESTING LABORATORIES, to his customer, supplier or others persons directly concerned. SHENZHEN TIMEWAY TESTING LABORATORIES, will not, without the consent of the client enter into any discussion of correspondence with any third party concerning the contents of the report.

In the event of the improper use of the report, the SHENZHEN TIMEWAY TESTING LABORATORIES, reserves the rights to withdraw it and to adopt any other remedies which may be appropriate.



### 14.0 Power Frequency magnetic field test

#### 14.1 Schematics of the test



#### 14.2 Test Method

The test was performed in accordance with EN 61000-4-8: 2010

Severity: Level 2 (3A/m),

Performance Criterion Require: A (Please see following table)

#### Block diagram of Test setup

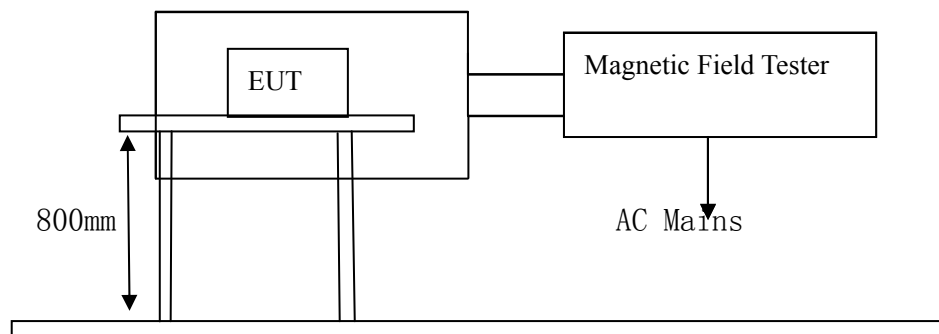

#### 14.3 Susceptibility performance Criteria and Severity Level

##### Susceptibility performance Criteria

A	Normal performance within the specification limits
B	Temporary degradation or loss of function or performance which is self recoverable
C	Temporary degradation or loss of function or performance which requires operator intervention or system reset
D	Degradation or loss of function which is not recoverable due to damage of equipment(components) or software, or loss of data

##### Severity Level

Severity Level	Magnetic Field Strength A/m
1	1
2	3
3	10

The report refers only to the sample tested and does not apply to the bulk.

This report is issued in confidence to the client and it will be strictly treated as such by the SHENZHEN TIMEWAY TESTING LABORATORIES. It may not be reproduced rather in its entirety or in part and it may not be used for advertising. The client to whom the report is issued may, however, show or send it, or a certified copy thereof prepared by the SHENZHEN TIMEWAY TESTING LABORATORIES, to his customer, Supplier or others persons directly concerned. SHENZHEN TIMEWAY TESTING LABORATORIES, will not, without the consent of the client enter into any discussion of correspondence with any third party concerning the contents of the report.

In the event of the improper use of the report, The SHENZHEN TIMEWAY TESTING LABORATORIES, reserves the rights to withdraw it and to adopt any other remedies which may be appropriate.





4	30
5	100
*	Special

14.4 Test Results:

Please refer to the following page

Test Level	Testing Duration	Coil Orientation	Criterion	Result
3A/m	5 Mins	Horizontal	A	N/A
3A/m	5 Mins	Vertical	A	N/A

The report refers only to the sample tested and does not apply to the bulk.

This report is issued in confidence to the client and it will be strictly treated as such by the SHENZHEN TIMEWAY TESTING LABORATORIES. It may not be reproduced rather in its entirety or in part and it may not be used for advertising. The client to whom the report is issued may, however, show or send it . or a certified copy there of prepared by the SHENZHEN TIMEWAY TESTING LABORATORIES. to his customer. Supplier or others persons directly concerned. SHENZHEN TIMEWAY TESTING LABORATORIES. will not, without the consent of the client enter into any discussion of correspondence with any third party concerning the contents of the report.

In the event of the improper use of the report. The SHENZHEN TIMEWAY TESTING LABORATORIES. reserves the rights to withdraw it and to adopt any other remedies which may be appropriate.



**15.0 Voltage Dips/Interruptions immunity test**

15.1 Schematics of the test



15.2 Test Method:

The test was performed in accordance with EN 61000-4-11: 2004

Performance Criterion Require: C&B (Please see following table)

**Block diagram of Test setup**

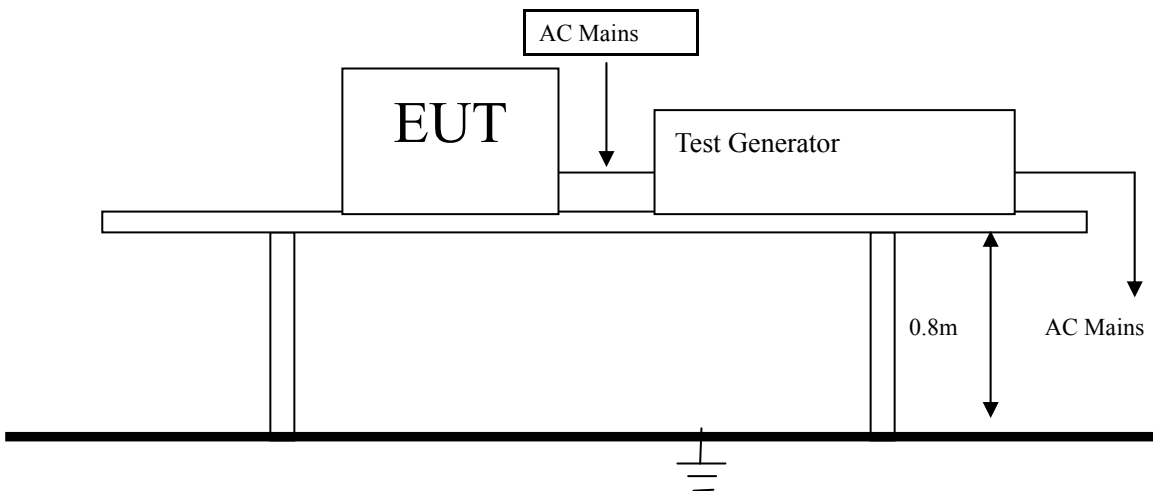

15.3 Susceptibility performance Criteria and Severity Level

Susceptibility performance Criteria

A	Normal performance within the specification limits
B	Temporary degradation or loss of function or performance which is self recoverable
C	Temporary degradation or loss of function or performance which requires operator intervention or system reset
D	Degradation or loss of function which is not recoverable due to damage of equipment(components) or software, or loss of data

The report refers only to the sample tested and does not apply to the bulk.

This report is issued in confidence to the client and it will be strictly treated as such by the SHENZHEN TIMEWAY TESTING LABORATORIES. It may not be reproduced rather in its entirety or in part and it may not be used for adverting. The client to whom the report is issued may, however, show or send it . or a certified copy there of prepared by the SHENZHEN TIMEWAY TESTING LABORATORIES. to his customer. Supplier or others persons directly concerned. SHENZHEN TIMEWAY TESTING LABORATORIES. will not, without the consent of the client enter into any discussion of correspondence with any third party concerning the contents of the report.

In the event of the improper use of the report. The SHENZHEN TIMEWAY TESTING LABORATORIES. reserves the rights to withdraw it and to adopt any other remedies which may be appropriate.



Severity Level

Test Level %Ut	Voltage dip and short interruptions %Ut	Duration(in period)
0	100	0.5 1
40	60	5 10
70	30	25 50 *

15.4 Test Result:

Please refer to the following page

Test Level % Ut	Voltage dips &short interruptions % Ut	Duration(in period)	Phase Angle	Criterion	Result
0	100	0.5P	0° - 360°	B	Pass
70	30	10P	0° - 360°	C	Pass

The report refers only to the sample tested and does not apply to the bulk.

This report is issued in confidence to the client and it will be strictly treated as such by the SHENZHEN TIMEWAY TESTING LABORATORIES. It may not be reproduced rather in its entirety or in part and it may not be used for adverting. The client to whom the report is issued may, however, show or send it . or a certified copy there of prepared by the SHENZHEN TIMEWAY TESTING LABORATORIES. to his customer. Supplier or others persons directly concerned. SHENZHEN TIMEWAY TESTING LABORATORIES. will not, without the consent of the client enter into any discussion of correspondence with any third party concerning the contents of the report.

In the event of the improper use of the report. The SHENZHEN TIMEWAY TESTING LABORATORIES. reserves the rights to withdraw it and to adopt any other remedies which may be appropriate.



## 16.0 Product Labelling

### 16.1 CE Mark label specification

Text of the mark is black or white in color and is left justified. Labels are printed in indelible ink on permanent adhesive backing and shall be affixed at a conspicuous location on the EUT or silk-screened onto the EUT.



### 16.2 Mark Location: Rear enclosure

The report refers only to the sample tested and does not apply to the bulk.

This report is issued in confidence to the client and it will be strictly treated as such by the SHENZHEN TIMEWAY TESTING LABORATORIES. It may not be reproduced rather in its entirety or in part and it may not be used for advertising. The client to whom the report is issued may, however, show or send it . or a certified copy there of prepared by the SHENZHEN TIMEWAY TESTING LABORATORIES. to his customer. Supplier or others persons directly concerned. SHENZHEN TIMEWAY TESTING LABORATORIES. will not, without the consent of the client enter into any discussion of correspondence with any third party concerning the contents of the report.

In the event of the improper use of the report. The SHENZHEN TIMEWAY TESTING LABORATORIES. reserves the rights to withdraw it and to adopt any other remedies which may be appropriate.



Appendix:

Photos of Testing

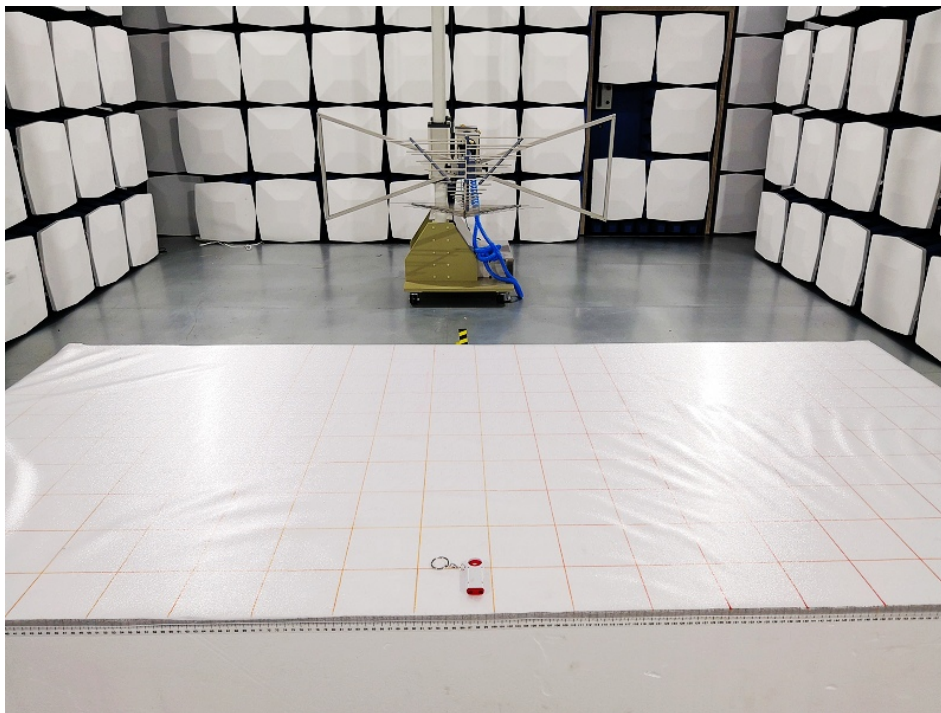

The report refers only to the sample tested and does not apply to the bulk.

This report is issued in confidence to the client and it will be strictly treated as such by the SHENZHEN TIMEWAY TESTING LABORATORIES. It may not be reproduced rather in its entirety or in part and it may not be used for advertising. The client to whom the report is issued may, however, show or send it . or a certified copy there of prepared by the SHENZHEN TIMEWAY TESTING LABORATORIES. to his customer. Supplier or others persons directly concerned. SHENZHEN TIMEWAY TESTING LABORATORIES. will not, without the consent of the client enter into any discussion of correspondence with any third party concerning the contents of the report.

In the event of the improper use of the report. The SHENZHEN TIMEWAY TESTING LABORATORIES. reserves the rights to withdraw it and to adopt any other remedies which may be appropriate.



Appendix:  
Photos of the Product



The report refers only to the sample tested and does not apply to the bulk.  
This report is issued in confidence to the client and it will be strictly treated as such by the SHENZHEN TIMEWAY TESTING LABORATORIES. It may not be reproduced rather in its entirety or in part and it may not be used for advertising. The client to whom the report is issued may, however, show or send it, or a certified copy thereof prepared by the SHENZHEN TIMEWAY TESTING LABORATORIES, to his customer, supplier or other persons directly concerned. SHENZHEN TIMEWAY TESTING LABORATORIES, will not, without the consent of the client enter into any discussion of correspondence with any third party concerning the contents of the report.  
In the event of the improper use of the report, the SHENZHEN TIMEWAY TESTING LABORATORIES, reserves the rights to withdraw it and to adopt any other remedies which may be appropriate.



Appendix:  
Photos of the Product



The report refers only to the sample tested and does not apply to the bulk.

This report is issued in confidence to the client and it will be strictly treated as such by the SHENZHEN TIMEWAY TESTING LABORATORIES. It may not be reproduced in its entirety or in part and it may not be used for advertising. The client to whom the report is issued may, however, show or send it, or a certified copy thereof prepared by the SHENZHEN TIMEWAY TESTING LABORATORIES, to his customer, supplier or other persons directly concerned. SHENZHEN TIMEWAY TESTING LABORATORIES will not, without the consent of the client, enter into any discussion of correspondence with any third party concerning the contents of the report.

In the event of the improper use of the report, the SHENZHEN TIMEWAY TESTING LABORATORIES reserves the rights to withdraw it and to adopt any other remedies which may be appropriate.



Appendix:

Photos of Testing



The report refers only to the sample tested and does not apply to the bulk.

This report is issued in confidence to the client and it will be strictly treated as such by the SHENZHEN TIMEWAY TESTING LABORATORIES. It may not be reproduced rather in its entirety or in part and it may not be used for advertising. The client to whom the report is issued may, however, show or send it, or a certified copy thereof prepared by the SHENZHEN TIMEWAY TESTING LABORATORIES, to his customer, supplier or other persons directly concerned. SHENZHEN TIMEWAY TESTING LABORATORIES, will not, without the consent of the client enter into any discussion of correspondence with any third party concerning the contents of the report.

In the event of the improper use of the report, the SHENZHEN TIMEWAY TESTING LABORATORIES, reserves the rights to withdraw it and to adopt any other remedies which may be appropriate.



Appendix:

Photos of Testing

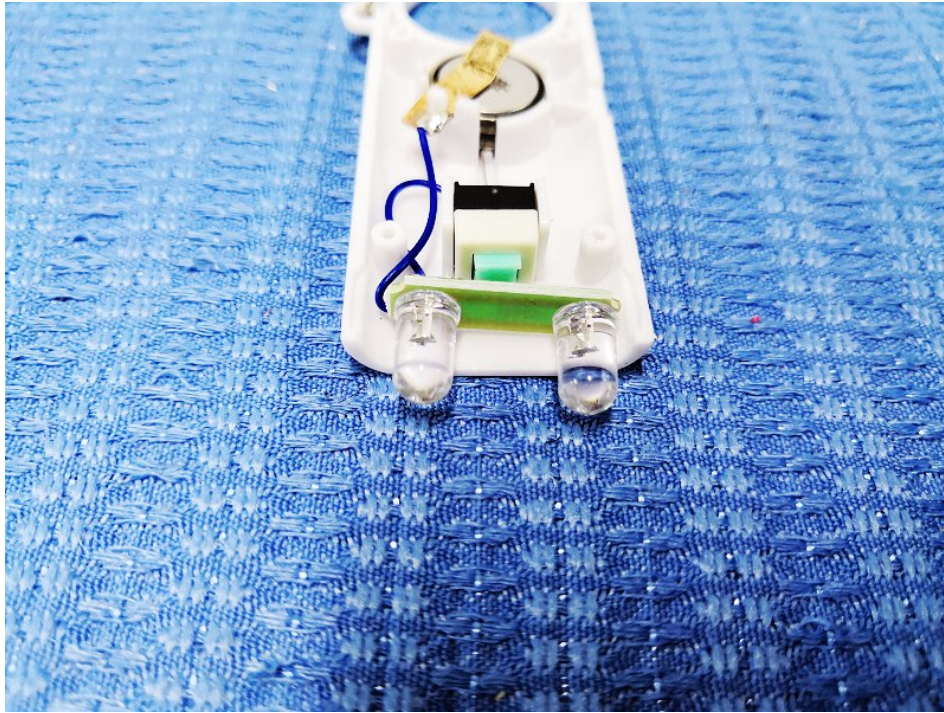

The report refers only to the sample tested and does not apply to the bulk.

This report is issued in confidence to the client and it will be strictly treated as such by the SHENZHEN TIMEWAY TESTING LABORATORIES. It may not be reproduced rather in its entirety or in part and it may not be used for advertising. The client to whom the report is issued may, however, show or send it . or a certified copy there of prepared by the SHENZHEN TIMEWAY TESTING LABORATORIES. to his customer. Supplier or others persons directly concerned. SHENZHEN TIMEWAY TESTING LABORATORIES. will not, without the consent of the client enter into any discussion of correspondence with any third party concerning the contents of the report.

In the event of the improper use of the report. The SHENZHEN TIMEWAY TESTING LABORATORIES. reserves the rights to withdraw it and to adopt any other remedies which may be appropriate.





**-End of the report-**

The report refers only to the sample tested and does not apply to the bulk.

This report is issued in confidence to the client and it will be strictly treated as such by the SHENZHEN TIMEWAY TESTING LABORATORIES. It may not be reproduced rather in its entirety or in part and it may not be used for advertising. The client to whom the report is issued may, however, show or send it . or a certified copy there of prepared by the SHENZHEN TIMEWAY TESTING LABORATORIES. to his customer. Supplier or others persons directly concerned. SHENZHEN TIMEWAY TESTING LABORATORIES. will not, without the consent of the client enter into any discussion of correspondence with any third party concerning the contents of the report.

In the event of the improper use of the report. The SHENZHEN TIMEWAY TESTING LABORATORIES. reserves the rights to withdraw it and to adopt any other remedies which may be appropriate.