



中国认可
国际互认
检测
TESTING
CNAS L6478



TEST REPORT

Reference No. : WTF19F09064838C

Applicant : Mid Ocean Brands B.V.

Address : 7/F., Kings Tower, 111 King Lam Street, Cheung Sha Wan, Kowloon, Hong Kong

Manufacturer : 107582

Sample Name : Metal rectangular key ring, Globy metal key ring, Heart metal key ring, Bottle opener key ring, House shaped key ring, Round shaped key ring, Metal key ring with house detail on the bottom. House shape stainless steel and ABS plastic key ring

Model No. : IT3020, KC6297, MO7155, MO8135, MO8461, MO8462, MO8693, MO8877

Test Method : Please refer to next page (s)

Test Conclusion : Please refer to next page (s)

Date of Receipt sample : 2019-09-18

Date of Test : 2019-09-18 to 2019-09-24

Date of Issue : 2019-09-24

Test Result : Please refer to next page (s)

Remarks:

The results shown in this test report refer only to the sample(s) tested; this test report cannot be reproduced, except in full, without prior written permission of the company. The report would be invalid without specific stamp of test institute and the signatures of compiler and approver.
If the report is not stamped with the accreditation recognized seal, it will only be used for scientific research, education, and internal quality control activities, and is not used for the purpose of issuing supporting data to the society.

Prepared By:

Waltek Services (Foshan) Co., Ltd.

Address: No.13-19, 2/F., 2nd Building, Sunlink International Machinery City, Chencun, Shunde District, Foshan, Guangdong, China

Tel:+86-757-23811398 Fax:+86-757-23811381 E-mail:info@waltek.com.cn

Compiled by:

Rena Chen

Rena.Chen / Project Engineer

Approved by:



Swing Liang

Swing.Liang / Lab Manager



- Test Requested..... :**
- 1) Determination of Cadmium content in the submitted sample in accordance with REACH regulation Annex XVII Entries 23 (EC) No. 1907/2006 and the amendment No. 552/2009, No. 494/2011, No. 835/2012 and (EU) 2016/217
 - 2) Determination of Lead content in the submitted sample in accordance with REACH regulation Annex XVII Entries 63 (EC) No. 1907/2006 and the amendment No. 836/2012 and (EU) 2015/628
 - 3) Determination of specified Phthalates content according to Annex XVII Items 51 & 52 of the REACH Regulation (EC) No. 1907/2006 & Amendment No. 552/2009 & No. 2018/2005
 - 4) Determine the specified AZO Colorants contents in the submitted sample in according to the Entries 43 in Annex XVII of the REACH Regulation (EC) No.1907/2006 and the Amendment Regulation (EC) No.552/ 2009 & No.126/ 2013 (previously restricted under Directive 2002/61/EC).



WALTEK

**Test Result:****1) Cadmium (Cd)**

Test Method: With reference to IEC 62321-5:2013, the analysis was performed by ICP-OES.

Test Item	MDL (mg/kg)	Results (mg/kg)		
		No.17	No.20	No.26
Cadmium(Cd)	2	ND	ND	ND
Conclusion	--	Pass	Pass	Pass

Note:

- (1) mg/kg = milligram per kilogram
- (2) ND = Not Detected (lower than MDL)
- (3) MDL = Method Detection Limit
- (4) Limit of Cadmium according to REACH regulation Annex XVII Item 23 (EC) No. 1907/2006 and the amendment No. 552/2009, No. 494/2011 and No. 835/2012 and (EU) 2016/217.

Category	Limit (mg/kg)
Wet paint	100
Surface coating	1000
Plastic	100
Metal parts of jewellery and hair accessories	100

2) Lead (Pb)

Test Method: With reference to IEC 62321-5:2013, the analysis was performed by ICP-OES.

Test Item	MDL (mg/kg)	Results (mg/kg)				Limit (mg/kg)
		No.1	No.2	No.3	No.4	
Lead(Pb)	2	ND	ND	ND	ND	500
Conclusion	--	Pass	Pass	Pass	Pass	--

Test Item	MDL (mg/kg)	Results (mg/kg)				Limit (mg/kg)
		No.5	No.6	No.7	No.8	
Lead(Pb)	2	30	ND	ND	38	500
Conclusion	--	Pass	Pass	Pass	Pass	--

Test Item	MDL (mg/kg)	Results (mg/kg)				Limit (mg/kg)
		No.9	No.10	No.11	No.12	
Lead(Pb)	2	25	ND	ND	ND	500
Conclusion	--	Pass	Pass	Pass	Pass	--



Test Item	MDL (mg/kg)	Results (mg/kg)				Limit (mg/kg)
		No.13	No.14	No.15	No.16	
Lead(Pb)	2	26	ND	ND	ND	500
Conclusion	--	Pass	Pass	Pass	Pass	--

Test Item	MDL (mg/kg)	Results (mg/kg)				Limit (mg/kg)
		No.17	No.18	No.19	No.20	
Lead(Pb)	2	ND	ND	26	ND	500
Conclusion	--	Pass	Pass	Pass	Pass	--

Test Item	MDL (mg/kg)	Results (mg/kg)				Limit (mg/kg)
		No.21	No.22	No.23	No.24	
Lead(Pb)	2	ND	ND	ND	ND	500
Conclusion	--	Pass	Pass	Pass	Pass	--

Test Item	MDL (mg/kg)	Results (mg/kg)		Limit (mg/kg)
		No.25	No.26	
Lead(Pb)	2	ND	ND	500
Conclusion	--	Pass	Pass	--

Note:

- (1) mg/kg = milligram per kilogram
- (2) ND = Not Detected (lower than MDL)
- (3) MDL = Method Detection Limit
- (4) Limit of Lead was quoted from REACH regulation Annex XVII Item 63 (EC) No. 1907/2006 and the amendment No. 836/2012 and (EU) 2015/628.



3) Phthalates

Test Method: With reference to EN14372:2004, by Gas Chromatographic-Mass Spectrometric (GC-MS) analysis.

Test Items	MDL (%)	Results (%)	Limit (%)
		No.26	
Benzyl butyl phthalate (BBP)	0.005	ND	sum of four phthalates < 0.1
Di (2-ethyl hexyl)- phthalate (DEHP)	0.005	ND	
Dibutyl phthalate (DBP)	0.005	ND	
Diisobutyl phthalate (DIBP)	0.005	ND	
Diisodecyl phthalate (DIDP)	0.01	ND	sum of three phthalates < 0.1
Diisononyl phthalate (DINP)	0.01	ND	
Di-n-octyl phthalate (DNOP)	0.005	ND	
Conclusion	--	Pass	--

Note:

DBP= Dibutyl phthalate

BBP= Benzyl butyl phthalate

DEHP= Bis-(2-ethylhexyl)- phthalate

DINP= Di-isononyl phthalate

DNOP= Di-n-octyl phthalate

DIDP= Di-isodecyl phthalate

DIBP= Diisobutyl phthalate

(1) % = percentage by weight

(2) ND = Not detected or Less than the method detection limit

(3) MDL=Method Detection Limit

(4) "<" = less than

(5) The above limit was quoted according to Annex XVII Items 51 & 52 of the REACH Regulation (EC) No. 1907/2006 & Amendment No. 552/2009 & No. 2018/2005 (formerly known as Directive 2005/84/EC) for phthalate content in toys and child care articles.



4) AZO

Test Method: With reference to BS EN ISO 14362-1: 2017 and BS EN ISO 14362-3: 2017, analysis was performed by Gas Chromatographic Mass Spectrometry (GC-MS)

No.	Amines Substances	CAS No.	Limit (mg/kg)	Result (mg/kg)	
				No.3	No.6
1	4-Aminobiphenyl	92-67-1	30	ND	ND
2	Benzidine	92-87-5	30	ND	ND
3	4-chloro-o-Toluidine	95-69-2	30	ND	ND
4	2-Naphthylamine	91-59-8	30	ND	ND
5	o-Aminoazotoluene	97-56-3	30	ND	ND
6	2-Amino-4-nitrotoluene	99-55-8	30	ND	ND
7	p-Chloroaniline	106-47-8	30	ND	ND
8	2,4-diaminoanisol	615-05-4	30	ND	ND
9	4,4'-Diaminodiphenylmethane	101-77-9	30	ND	ND
10	3,3'-Dichlorobenzidine	91-94-1	30	ND	ND
11	3,3'-Dimethoxybenzidine	119-90-4	30	ND	ND
12	3,3'-Dimethylbenzidine	119-93-7	30	ND	ND
13	3,3'-Dimethyl-4,4'-diaminodiphenylmethane	838-88-0	30	ND	ND
14	p-cresinin	120-71-8	30	ND	ND
15	4,4'-Methylen-bis-(2-chloroaniline)	101-14-4	30	ND	ND
16	4,4'-Oxydianiline	101-80-4	30	ND	ND
17	4,4'-Thiodianiline	139-65-1	30	ND	ND
18	o-Toluidine	95-53-4	30	ND	ND
19	2,4-Toluylendiamine	95-80-7	30	ND	ND
20	2,4,5 – Trimethylaniline	137-17-7	30	ND	ND
21	o-anisidine	90-04-0	30	ND	ND
22	4-aminoazobenzene	60-09-3	30	ND	ND
23	2,4-Xylidin	95-68-1	30	ND	ND
24	2,6-Xylidin	87-62-7	30	ND	ND
Conclusion		--	--	Pass	Pass

Note:

- ND = Not detected or less than the method detection limit
- mg/kg=Milligram per kilogram
- Method Detection Limit (mg/kg): Each 5mg/kg
- The CAS-numbers 97-56-3 and 99-55-8 are further reduced to CAS-numbers 95-53-4 and 95-80-7.
- AZO colorants that are able to form 4-aminoazobenzene, generate under the condition of this method aniline and 1,4-phenylenediamine. The presence of these colorants cannot be reliably ascertained without additional information, e.g. the chemical structure of the colorant used.
- The CAS-numbers 95-68-1 and 87-62-7 are not proscribed under REACH Regulation (EC) No 1907/2006



Test Specimen Description:

- No.1: Silvery metal ring
- No.2: Silvery metal sheet
- No.3: Blue fabric
- No.4: Silvery metal ring
- No.5: Silvery metal sheet
- No.6: Red fabric
- No.7: Silvery metal ring
- No.8: Silvery metal ring
- No.9: Silvery metal ring
- No.10: Silvery metal sheet
- No.11: Silvery metal pin
- No.12: Silvery metal ring
- No.13: Silvery metal sheet
- No.14: Silvery metal ring
- No.15: Silvery metal ring
- No.16: Silvery metal sheet
- No.17: Black plastic sheet
- No.18: Silvery metal ring
- No.19: Silvery metal sheet
- No.20: Black plastic sheet
- No.21: Silvery metal ring
- No.22: Silvery metal sheet
- No.23: Silvery metal ring
- No.24: Silvery metal sheet
- No.25: Silvery metal ring
- No.26: Blue plastic sheet



WALTEK



Sample photo:

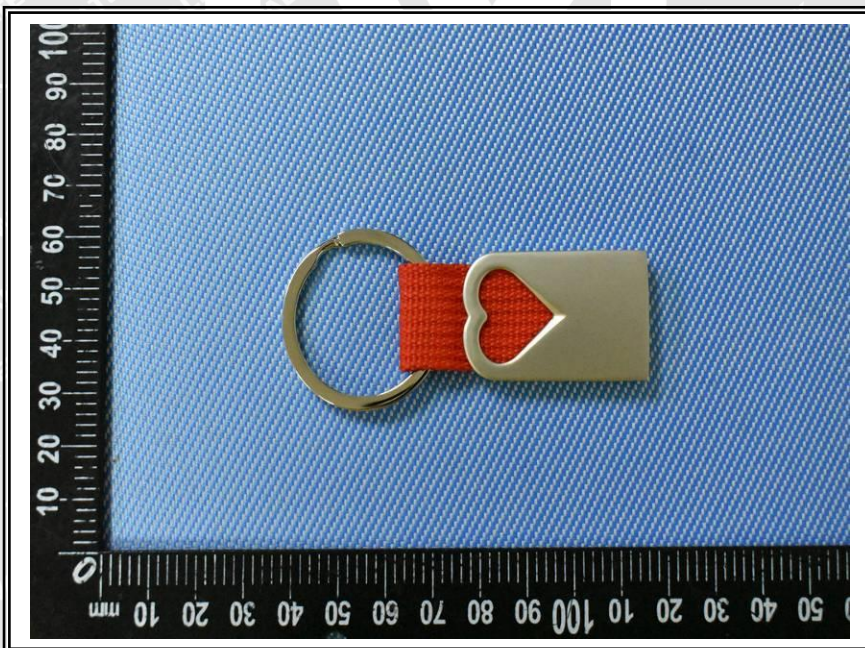
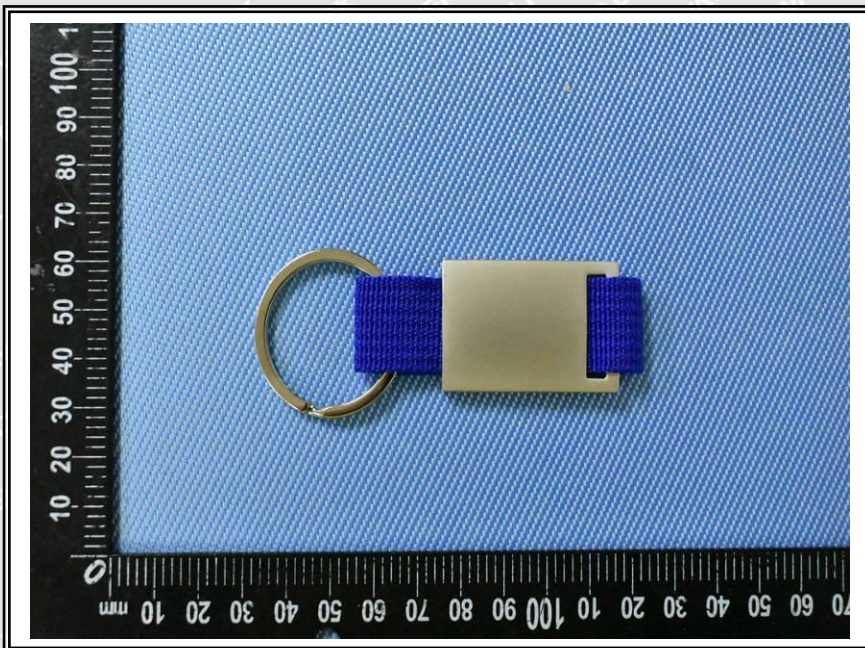



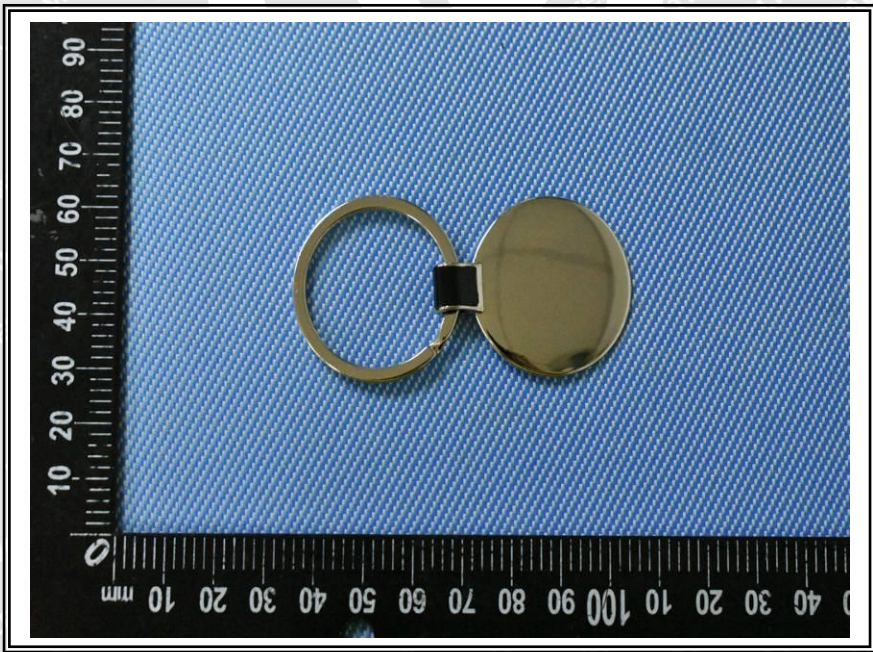

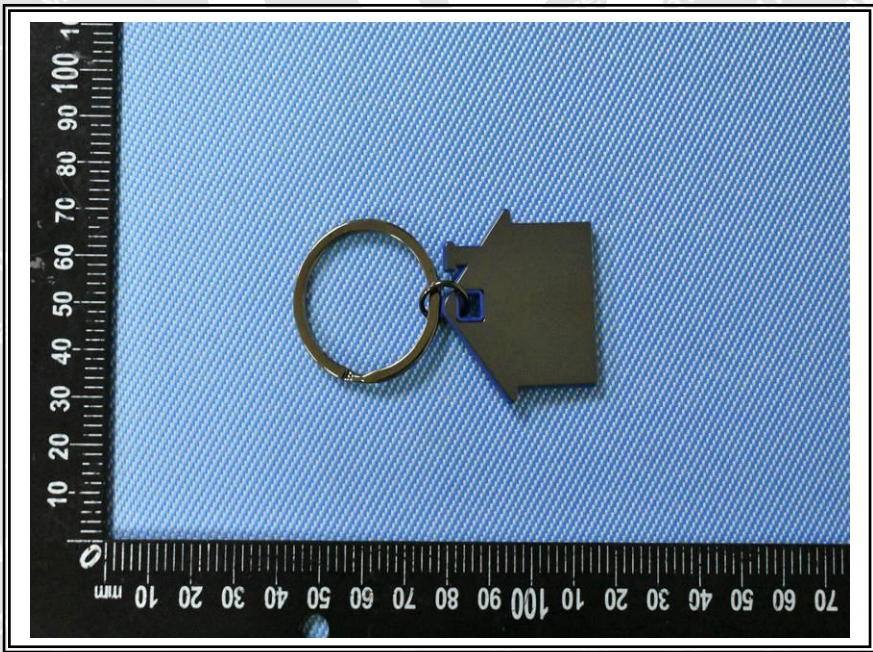
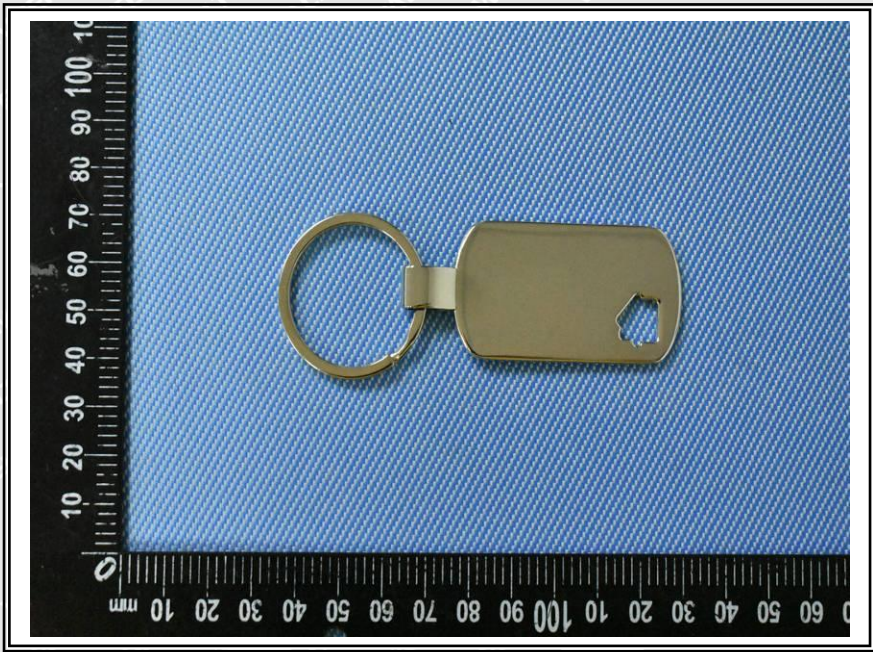



Photographs of parts tested:

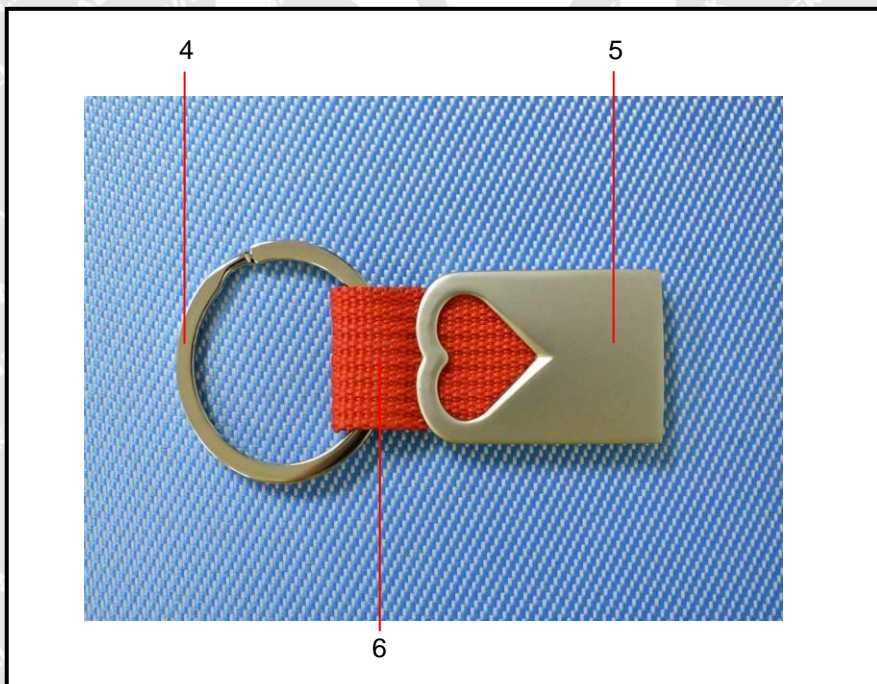
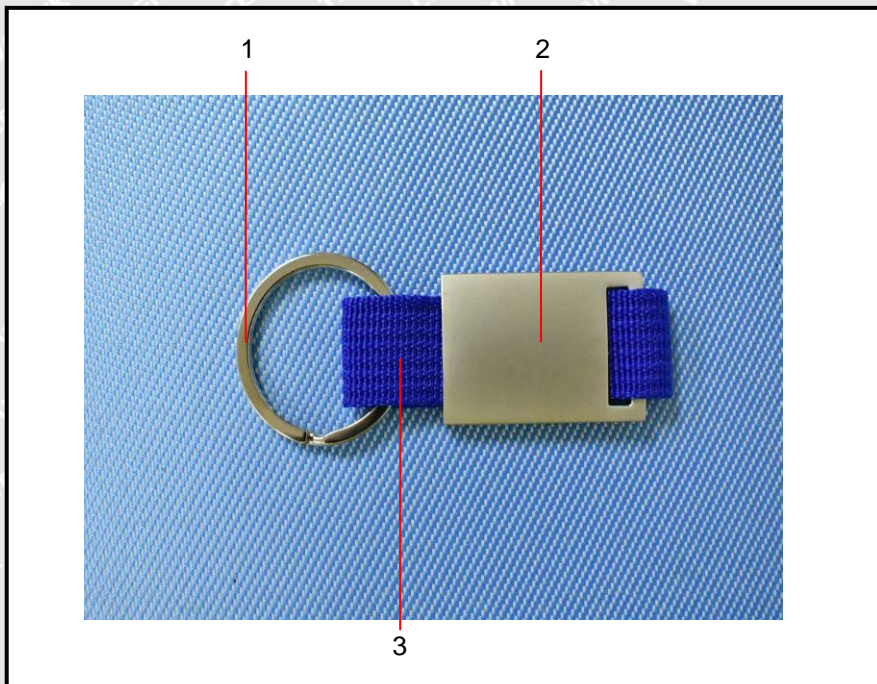

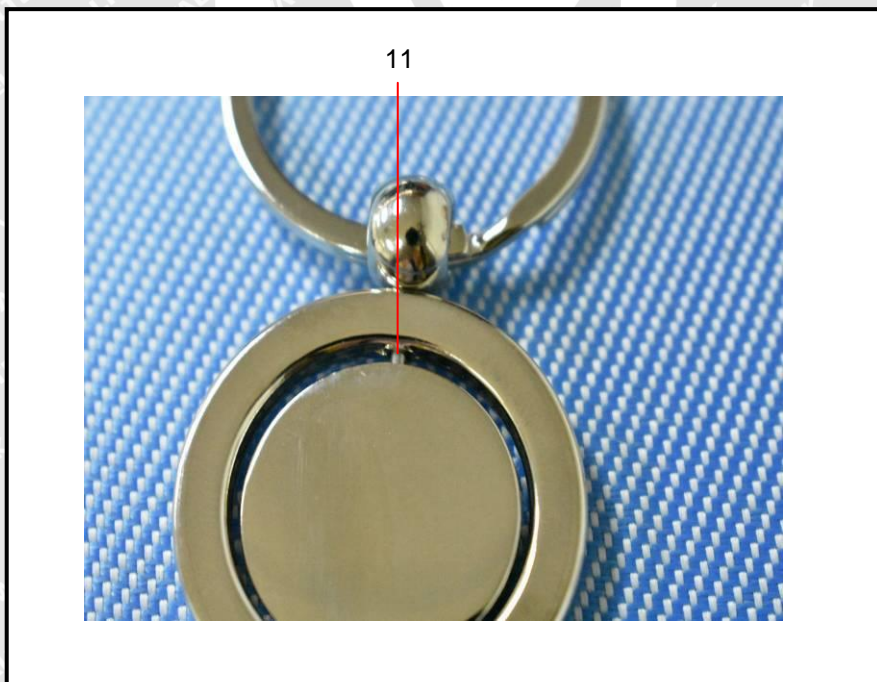
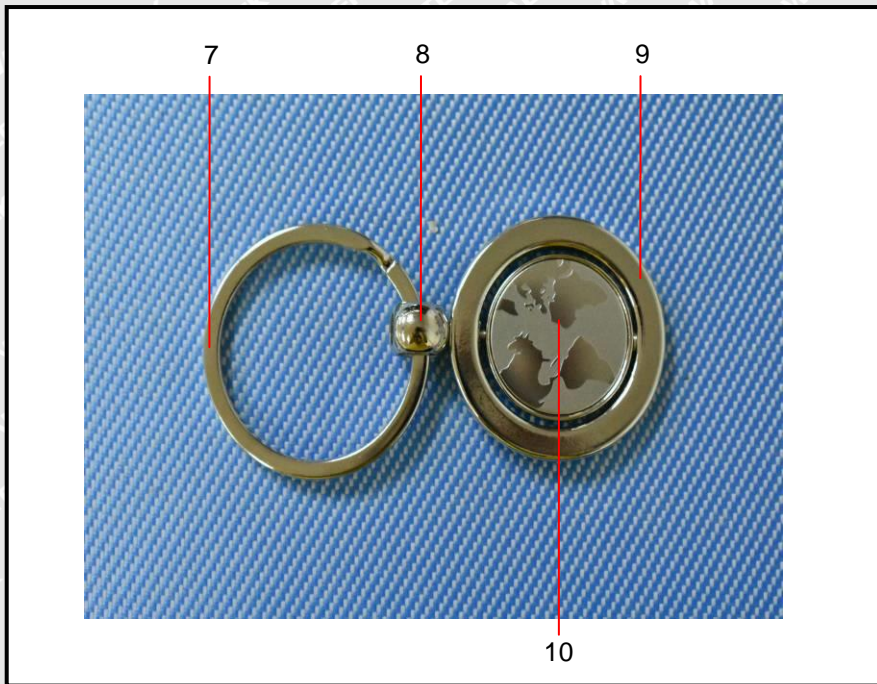

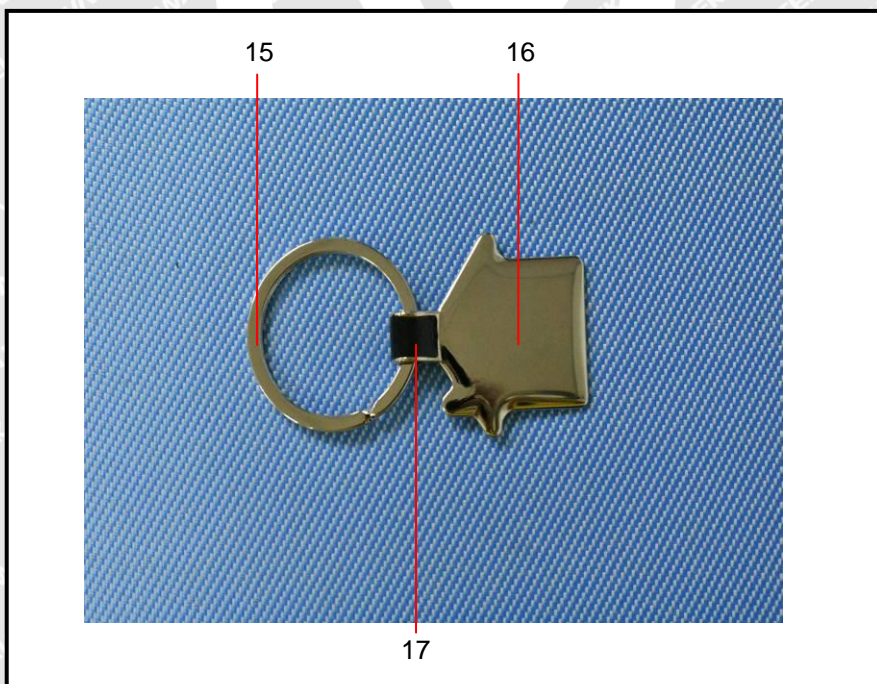
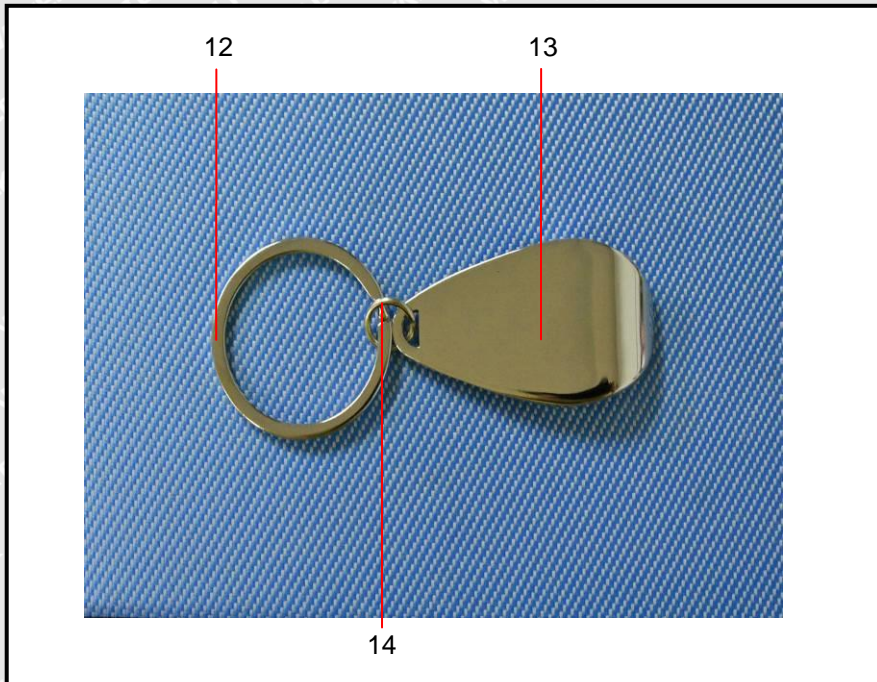

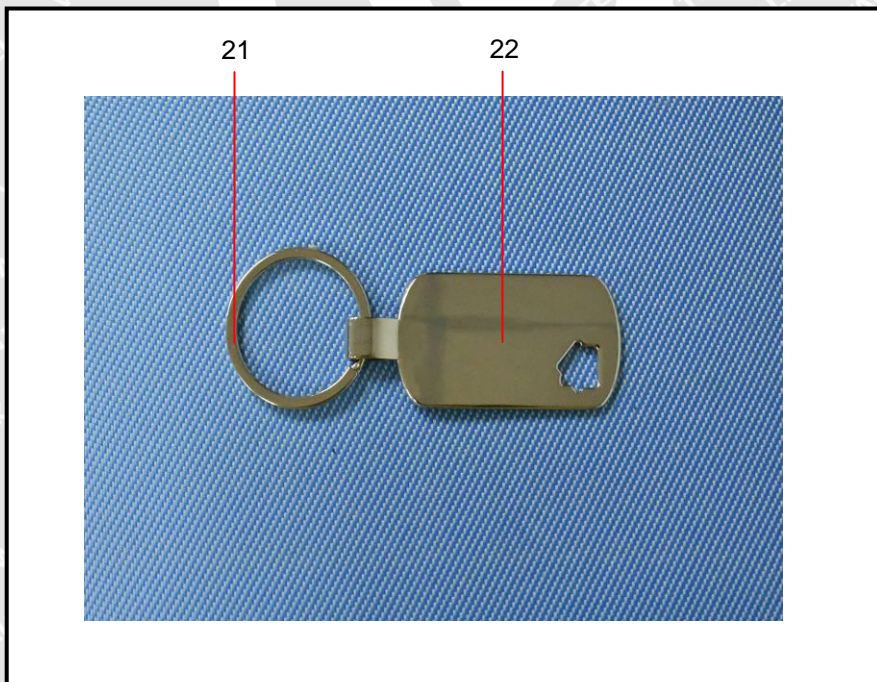
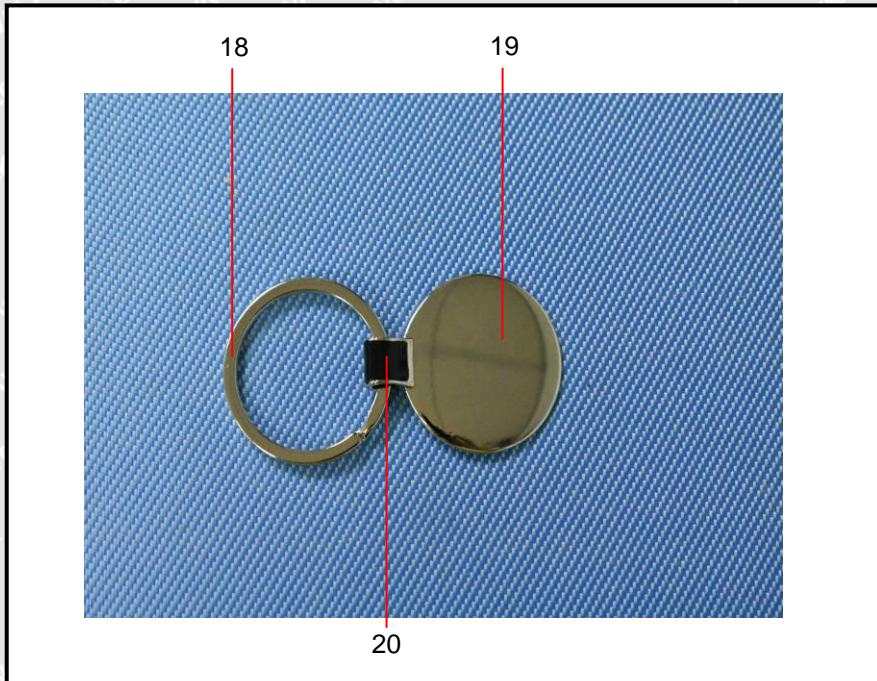

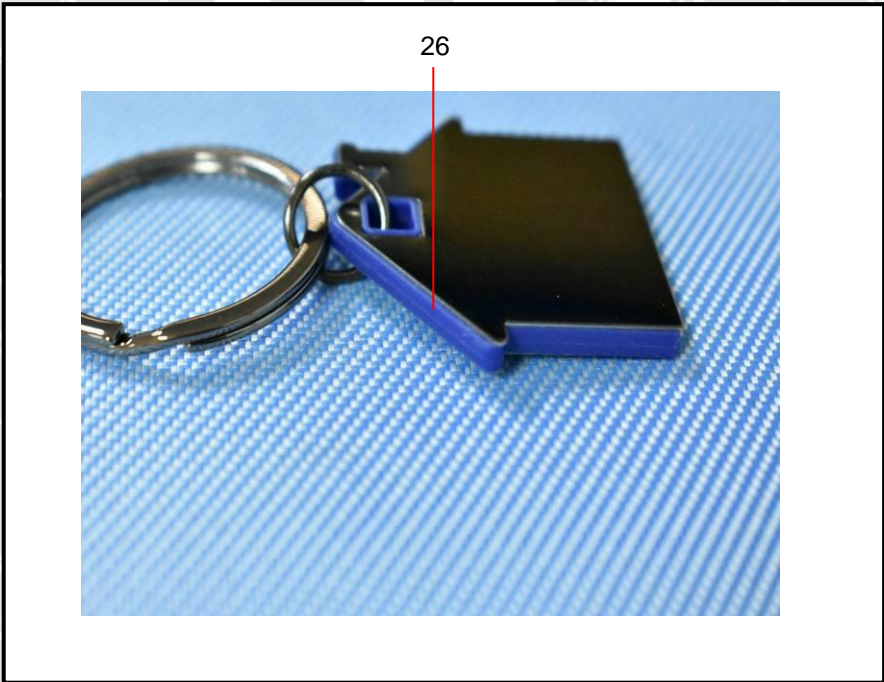
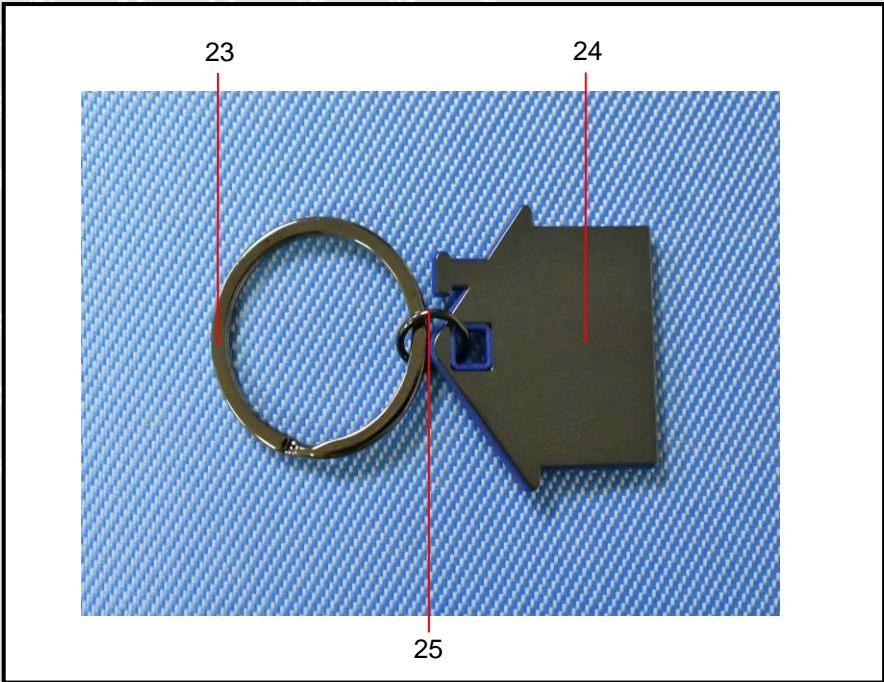

===== End of Report =====